



NARDI
YOUR OUTDOOR LIVING

OUTDOOR
2022

outdoor
design Raffaello Galiotto

O come Outdoor

Vivere all'aria aperta, con lo sguardo rivolto verso il mare, immersi nel verde o in un'oasi in città. Suggestioni di design e idee per abitare gli spazi esterni, scegliendo tra un vasto numero di collezioni, misure e colori.

I nostri arredi celebrano il desiderio di relax all'aperto, definiscono gli ambienti contemporanei con stile e personalità incontrando le esigenze di componibilità e versatilità.

Li realizziamo completamente in Italia con materiali di qualità adatti a restare all'esterno, sono riciclabili e pensati per un utilizzo intensivo e un lungo ciclo di vita.

O for Outdoor

Living in the open air, with a view of the sea, surrounded by greenery or in a green oasis in the city. Stylish design solutions and ideas for outdoor living, allowing you to choose from a large number of collections, dimensions and colours.

Our furniture enhances the desire to relax outdoors, adding style and personality to contemporary environments while meeting the need for modularity and versatility.

We make our furniture entirely in Italy using high-quality materials suited to remaining outdoors. It is recyclable and designed for intensive use and a long life cycle.

index

8	<i>komodo modular system</i>
36	dogo
44	<i>folio my special place</i>
60	rio / dogo · trill · net
78	set rio bench Alu
84	alloro · palma
94	net collection
104	aria
110	loto · ninfea
118	atlantico · pop
127	<i>schede tecniche/technical details</i>

Komodo *modular system*

Sistema di sedute imbottite modulare componibile a piacere per creare il proprio living a cielo aperto.

Ispirata all'intreccio dei rami degli alberi, la struttura dona grande personalità all'arredo, accoglie i cuscini in diversi colori e tessuti e si completa con la nuova copertura Ombra per vivere il piacere dell'aria aperta e della socialità protetti dal sole.

A modular upholstered seating system that can be arranged as required to create your open-air living space.

Inspired by the lattice pattern of tree branches, its frame adds great character to furnishings, accommodating cushions in various colours and fabrics. Komodo is complemented by the new Ombra covering so you can enjoy the pleasure of being in the open air and socialising, protected from the sun.



GOOD DESIGN
AWARD 2019
winner





KOMODO bianco / giungla
KOMODO OMBRA 2 bianco / velo white
KOMODO TAVOLINO bianco



KOMODO bianco / ghiaccio
KOMODO OMBRA 2 bianco / velo white
KOMODO TAVOLINO bianco





KOMODO antracite / canvas
 KOMODO OMBRA 3 antracite / velo white
 KOMODO TAVOLINO antracite

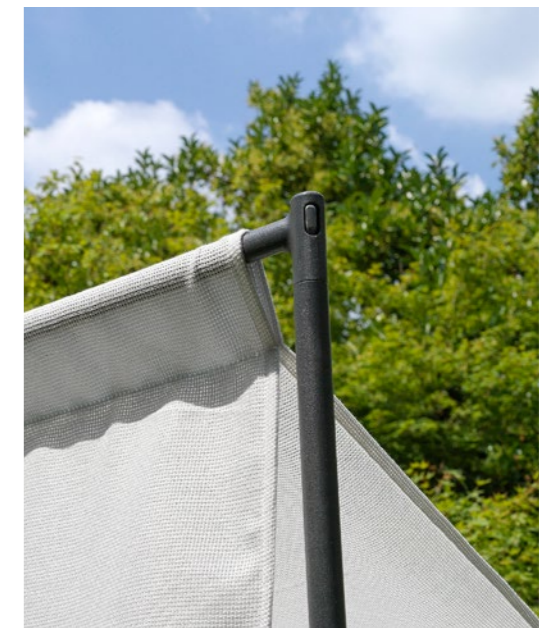



KOMODO agave / avocado - giungla
KOMODO TAVOLINO agave



KOMODO POLTRONA agave / giungla



KOMODO POLTRONA agave / avocado



KOMODO agave / avocado - giungla
KOMODO TAVOLINO agave





KOMODO bianco / canvas
KOMODO TAVOLINO VETRO bianco / vetro



KOMODO bianco / canvas
KOMODO TAVOLINO VETRO bianco / vetro

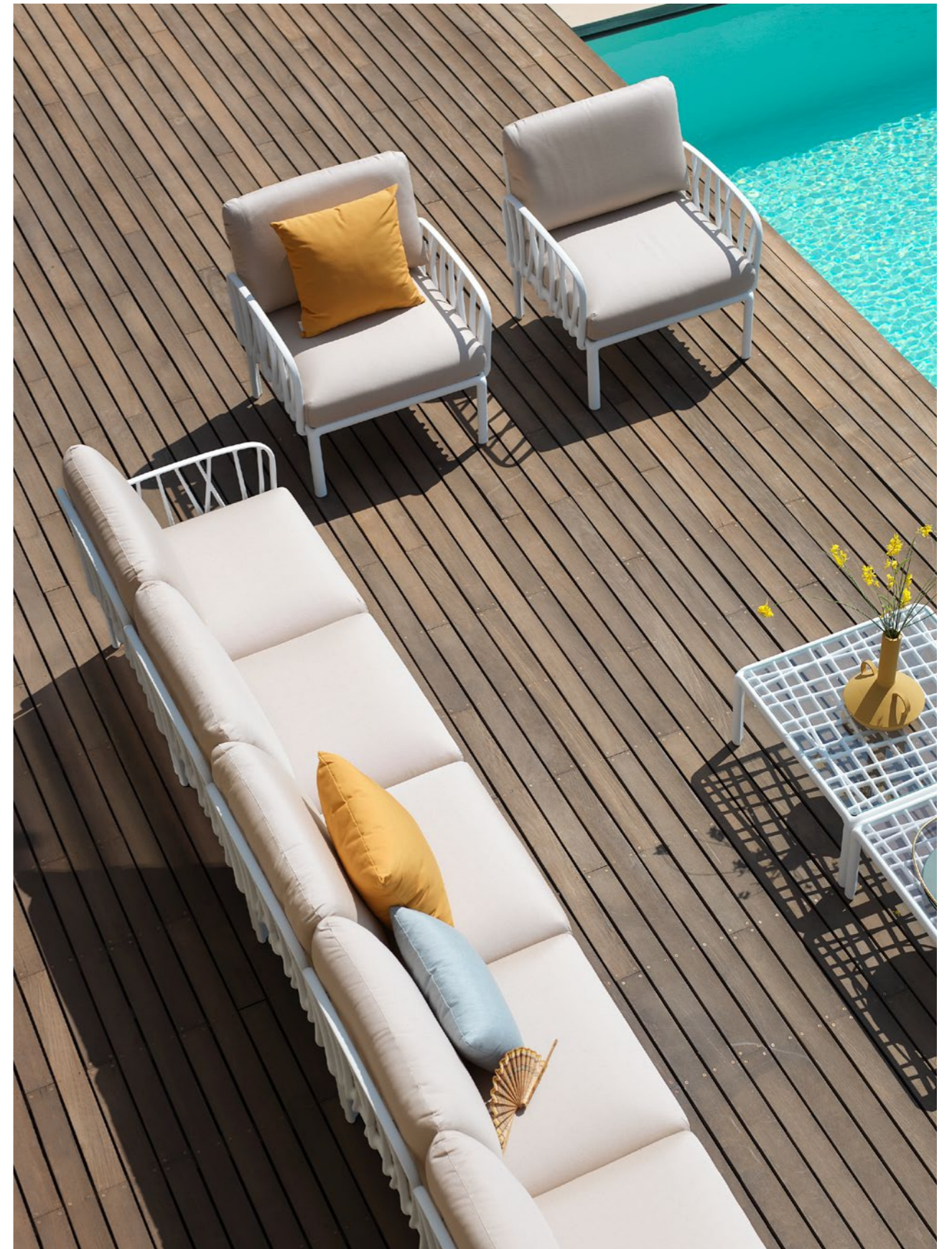



KOMODO TAVOLINO VETRO antracite / vetro



KOMODO antracite / rosa quarzo



KOMODO POLTRONA bianco / grigio komodo
 KOMODO TAVOLINO VETRO bianco / vetro



KOMODO TAVOLINO VETRO bianco / vetro

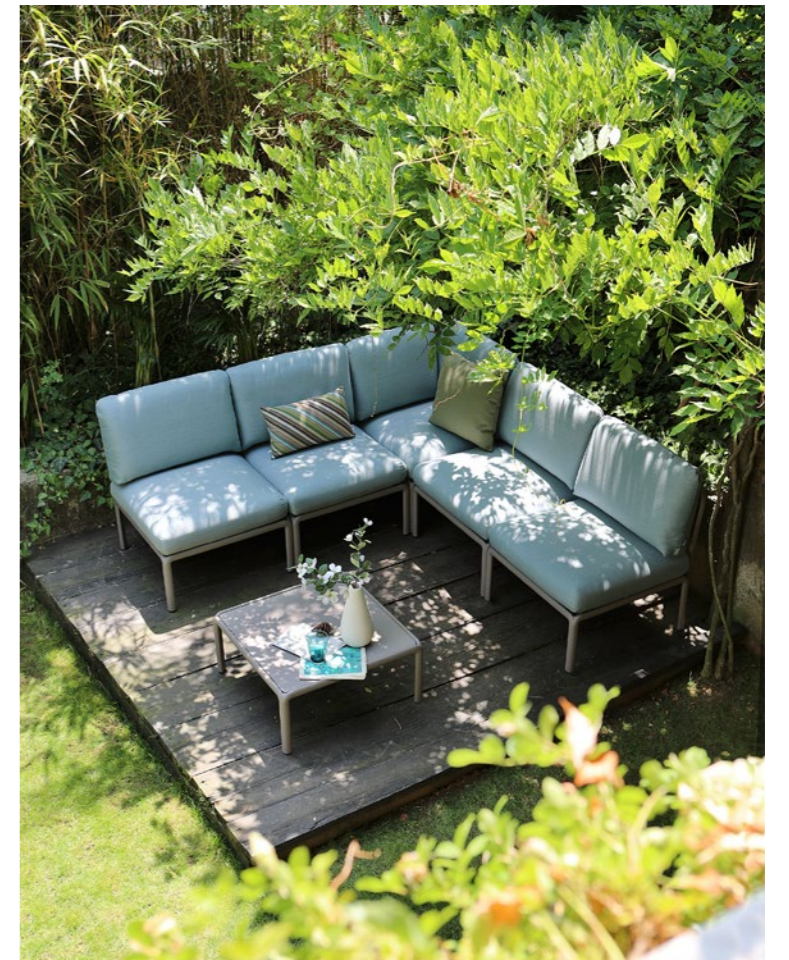

KOMODO 5 tortora / ghiaccio
KOMODO TAVOLINO tortora



FOLIO ROCKING tortora / lino
SIPARIO 3 terra

KOMODO 5 tortora / giungla
KOMODO POUF tortora / giungla
KOMODO TAVOLINO tortora



KOMODO 5 tortora / giungla
KOMODO POUF tortora / giungla
KOMODO TAVOLINO tortora
SIPARIO 3 terra



Doga

Inediti cromatismi, estetica e funzionalità, forme invitanti per godere della vita all'aria aperta.

Tutta la leggerezza di Doga, sedute con e senza braccioli e versione lounge, per una collezione fresca, dinamica e versatile ispirata al tema della doga reinterpretata in chiave contemporanea.

New colours, aesthetic design and functionality, with attractive shapes for enjoying life in the open air.

All the lightness of Doga chairs with and without armrests, and a lounge version for an original, dynamic and versatile collection inspired by a slatted design given a contemporary twist.





DOGA RELAX cappuccino - agave
DOGA TABLE agave



DOGA BISTROT agave / lino
 DOGA ARMCHAIR agave / lino
 DOGA RELAX agave / lino

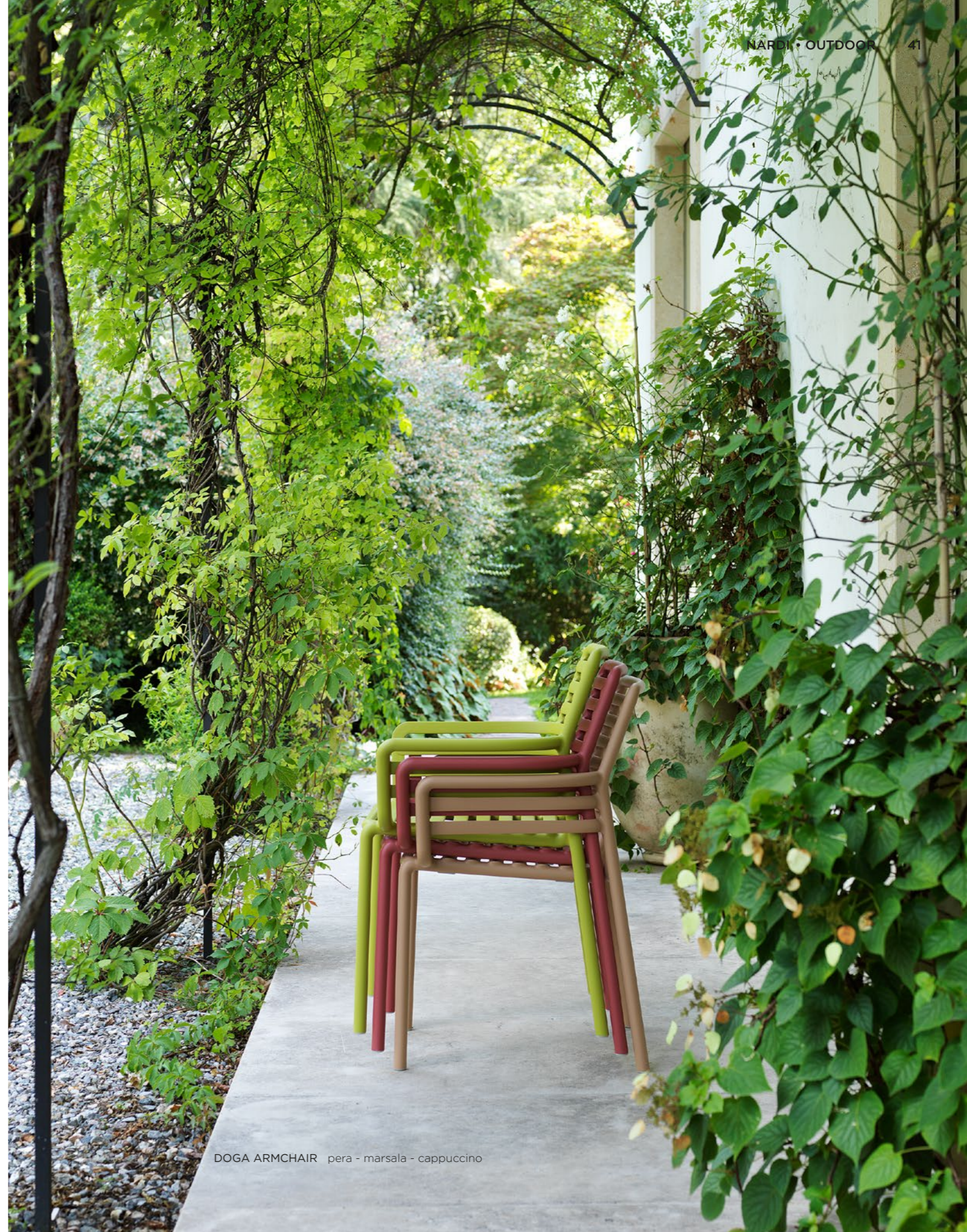

DOGA ARMCHAIR pera - marsala - cappuccino



DOGA RELAX pera
DOGA TABLE agave



Folio *my special place*

Il morbido e piacevole abbraccio di una poltrona davvero speciale.
Folio è un'innovativa poltrona relax proposta a base fissa o nella romantica versione a dondolo, reclinabile in due posizioni e completata dal poggiatesta/sgabello Poggio.
Uno stile curato nei dettagli, delineato dall'unione di linee pure, colori e imbottiti per incantevoli angoli di relax.

The soft and pleasant embrace of a very special armchair.

Folio is an innovative relaxing armchair available with a fixed base or in a romantic rocking version. It reclines to two positions and can be complemented with the Poggio footrest/stool.

Its style features meticulous details, highlighted by a combination of elegant lines, colours and padded elements that allow charming corners of relaxation to be created.



GOOD DESIGN
AWARD 2020
winner



archiproducts
DESIGN AWARDS
WINNER 2020



reddot winner 2021







FOLIO tabacco
POGGIO tabacco



FOLIO tabacco / felce
POGGIO tabacco



FOLIO antracite



FOLIO antracite / rosa quarzo
POGGIO antracite
SPRITZ antracite



FOLIO agave / artic





POGGIO agave



FOLIO bianco / lino
FOLIO ROCKING bianco / lino
POGGIO bianco



FOLIO agave / lino
POGGIO agave

Rio / Doga • Trill • Net

Chiacchierare, ridere, raccontare, trovare sempre un posto per chi arriva all'improvviso. Tavoli allungabili dalla movimentazione facile e invisibile, sedute di diverse forme, colori e gradi di comfort che permettono di creare scenografie outdoor su misura.

Chatting, laughing and telling stories, always finding a place for those who turn up unexpectedly. Tables that extend with a simple concealed movement and chairs in various shapes, colours and levels of comfort that allow you to create customised outdoor settings.





RIO ALU 210 EXTENSIBILE antracite
DOGA ARMCHAIR bianco - antracite
DOGA BISTROT bianco - antracite



RIO ALU 210 EXTENSIBLE antracite
 DOGA ARMCHAIR antracite
 DOGA BISTROT bianco

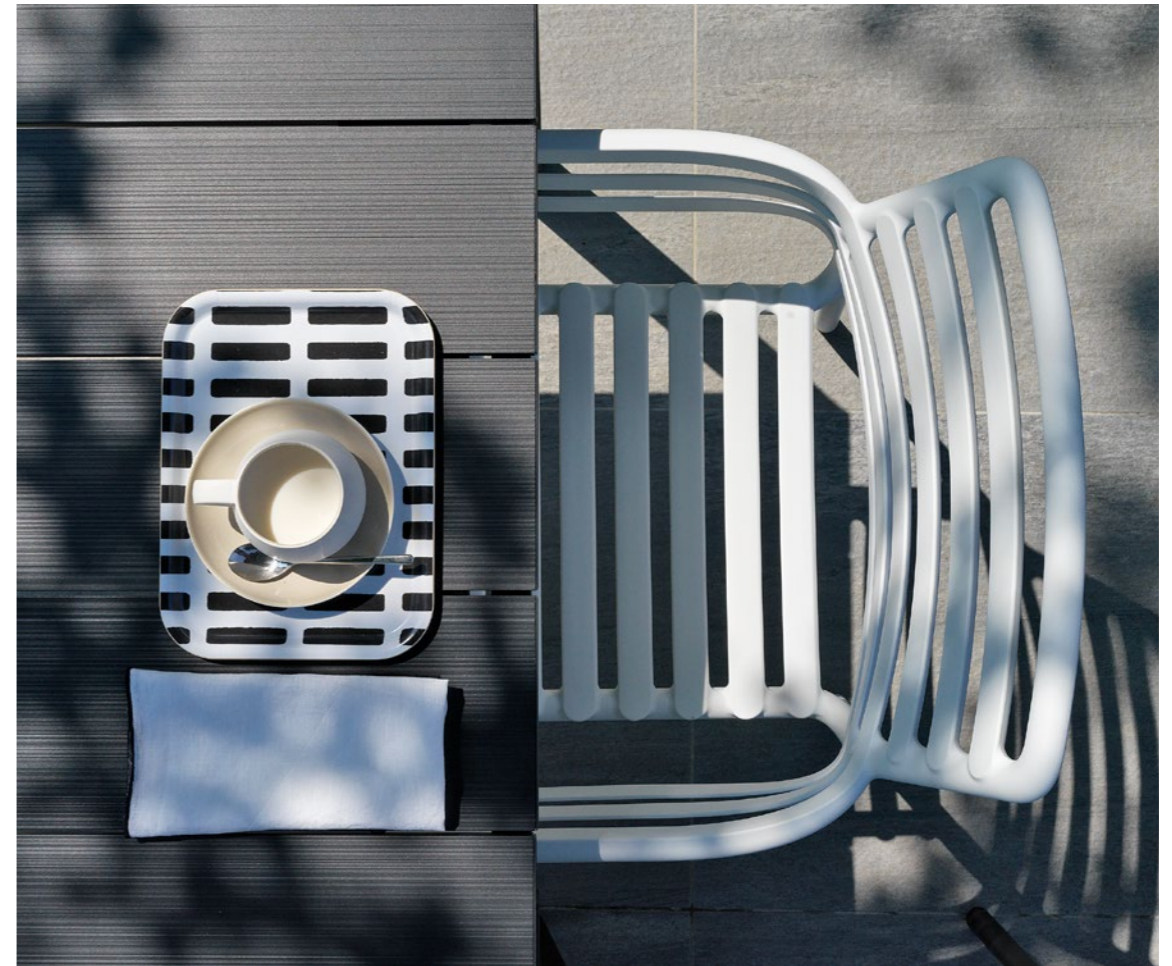

RIO ALU 210 EXTENSIBLE antracite
 DOGA ARMCHAIR bianco



RIO ALU 210 EXTENSIBLE antracite
TRILL ARMCHAIR agave



RIO ALU 210 EXTENSIBILE antracite
TRILL ARMCHAIR agave



RIO ALU 210 EXTENSIBILE antracite



RIO ALU 210 EXTENSIBLE antracite
NET senape



RIO ALU 210 EXTENSIBILE antracite
NET senape





RIO 210 EXTENSIBLE tortora
NET RELAX tortora / rosa quarzo



RIO 140 EXTENSIBLE bianco
BIT bianco



BIT salice

Set Rio Bench ALU

Nuove e informali idee per godere della convivialità a cielo aperto. La panca Rio Bench riprende le caratteristiche doghe del tavolo allungabile Rio e definisce gli ambienti outdoor in totale libertà accendendo la spensieratezza e la voglia di stare insieme.

New, informal ideas for enjoying convivial moments outdoors. Rio Bench echoes the characteristic slats of the extensible Rio table, freely creating outdoor environments while fostering light-heartedness and the desire to be together.





SET RIO BENCH ALU tortora



RIO BENCH ALU tortora



SET RIO BENCH ALU tortora

Alloro • Palma

Versatilità e facilità d'utilizzo sono le connotazioni dei tavoli allungabili Nardi che vantano alte prestazioni e disegnano conviviali scenari nel nome di tecnica e design. Le armoniose silhouette della struttura dei tavoli e delle sedute abbinata evocano quelle dei classici listelli di legno.

Nardi's extending tables are versatile and easy to use, offering high performance while creating convivial arrangements focused on technology and design. The harmonious silhouettes of the table frames and matching chairs are reminiscent of classic wooden slats.





ALLORO 210 EXTENSIBLE tortora / tortora
PALMA tortora / tortora



ALLORO 210 EXTENSIBLE tortora / tortora
PALMA tortora / tortora



ALLORO 210 EXTENSIBLE tortora / tortora



ALLORO 140 EXTENSIBLE bianco / tortora
PALMA bianco / tortora

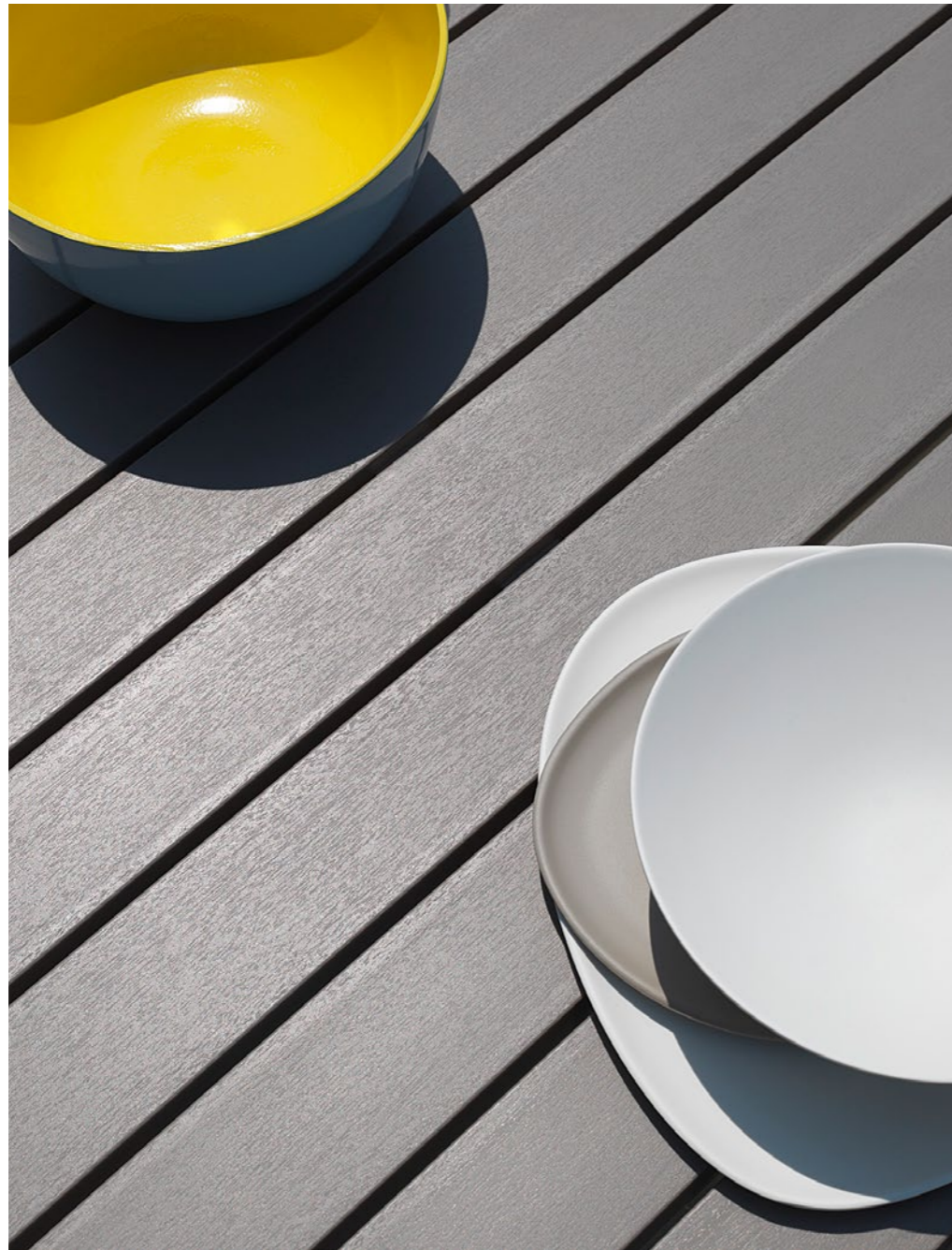

ALLORO 140 EXTENSIBLE bianco / tortora



PALMA bianco / tortora

Net collection

Raffinato relax, interpretato da armoniche palette di colori che si compongono e contrappongono in un gioco di elementi - poltroncine, divanetti, tavolini e cuscini - che dialogano tra loro per personali look open air.

Refined relaxation is expressed with harmonious colour palettes that are combined and contrasted in an interplay of elements - armchairs, sofas, side tables and cushions - that come together for a personal open-air look.

NET RELAX awards



GOOD DESIGN
AWARD 2018
winner



reddot award 2018
winner



selected by
ADI DESIGN
INDEX 2017





NET BENCH salice / sardinia
NET RELAX salice / sardinia
NET TABLE 100 salice



NET RELAX salice / sardinia



NET TABLE 100 salice



NET BENCH bianco / grigio
NET RELAX bianco / grigio
NET TABLE 100 bianco



NET BENCH senape / denim
CUSCINO PASSEPARTOUT denim



NET BENCH senape / denim
NET RELAX senape / denim
NET TABLE 100 senape

Aria

Progettare salotti all'aperto per godere delle serate in compagnia, della brezza del mare, dell'aria fresca di montagna. Le doghe, fil rouge stilistico della collezione, disegnano poltroncine e tavolini personalizzabili con una vasta scelta di cuscini di diverse forme e colori.

Creating outdoor lounges for enjoying evenings in company, with a sea breeze or fresh mountain air.

Slats, the recurring stylistic theme of the collection, give shape to armchairs and side tables that can be customised with a wide choice of cushions in various shapes and colours.





ARIA POLTRONA bianco / sardinia
ARIA TAVOLINO 100 bianco



ARIA POLTRONA tortora / lime
ARIA TAVOLINO 100 tortora

Loto • Ninfea

Atmosfere contemporanee, create attraverso l'incontro di diversi materiali - vetro, metallo, resina - che sottolineano la qualità e la ricercatezza di una collezione che assolve alle tante esigenze del vivere gli spazi all'aperto.

Contemporary atmospheres, created by combining different materials - glass, metal, resin - that underline the quality and refinement of a collection that meets the many requirements of outdoor living.





LOTO DINNER 190 antracite / antracite
NINFEA DINNER antracite / antracite





LOTTO RELAX 95 bianco / bianco
NINFEA RELAX bianco / bianco



NINFEA RELAX bianco / bianco



LOTO RELAX 95 bianco / bianco

Atlantico • Pop

Rituali di benessere sia per gli occhi che per il corpo. Atlantico e Pop uniscono la massima ergonomia alla qualità di dettagli e materiali. Un concept estetico dalle linee pure ed essenziali in un'ampia scelta di colori.

Rituals of wellbeing for the eyes and the body.

Atlantico and Pop combine excellent ergonomics with quality details and materials. An aesthetic concept with simple elegant lines and a wide choice of colours.





ATLANTICO tortora / agave

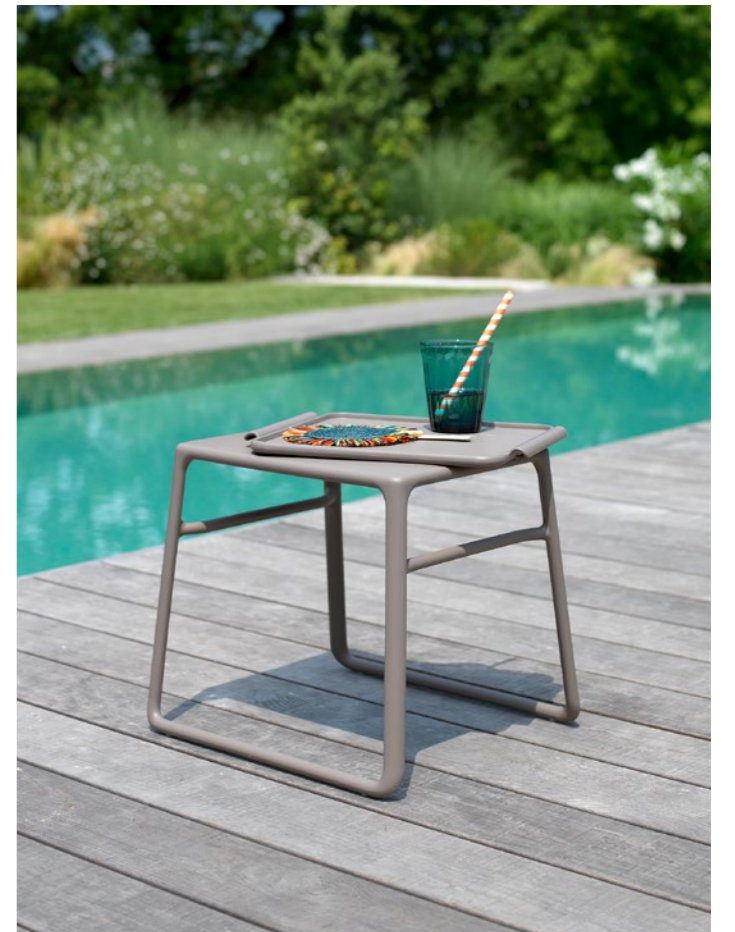

POP tortora



ATLANTICO bianco / bianco
POP bianco



ATLANTICO antracite / antracite
POP antracite

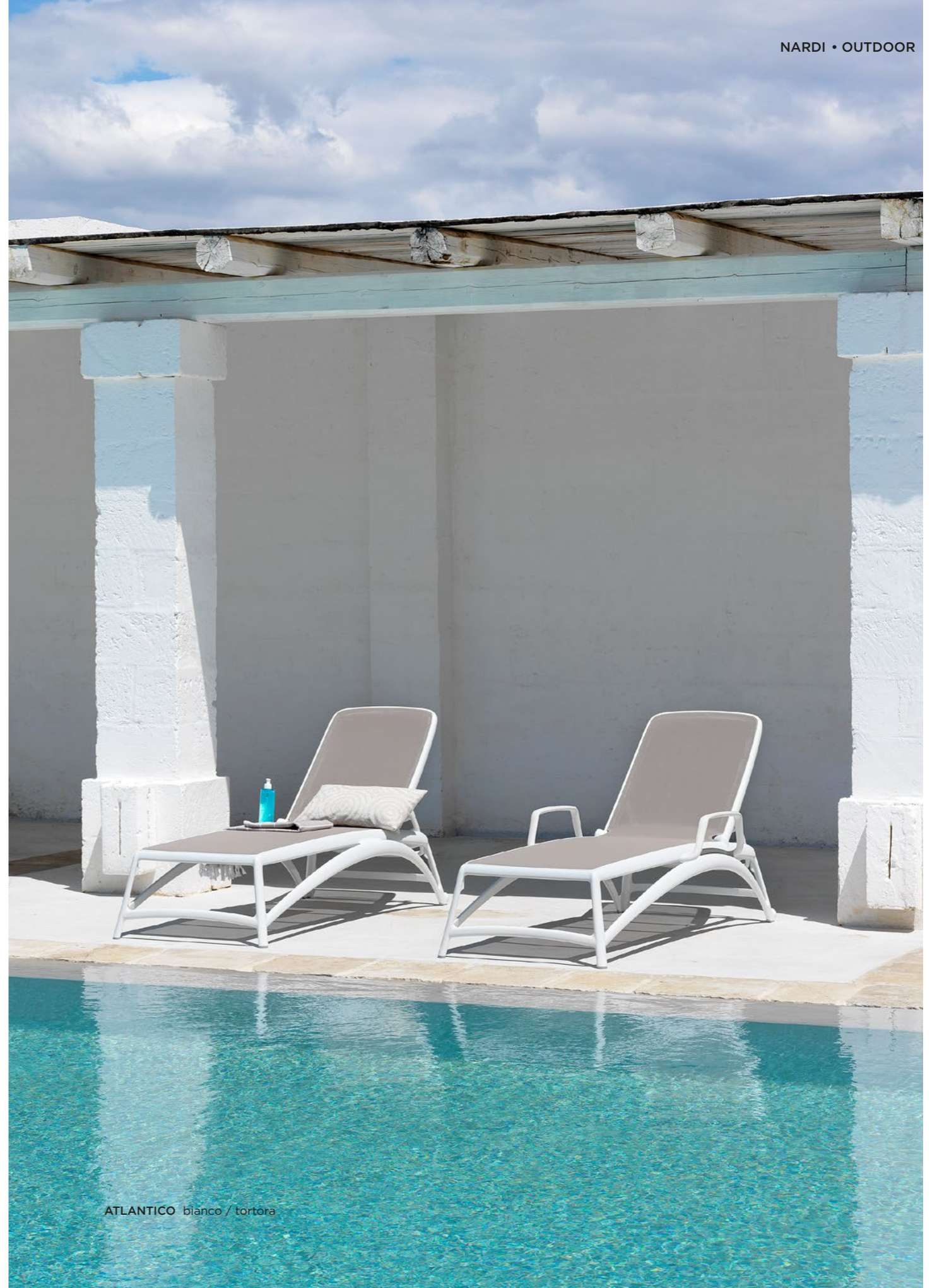

ATLANTICO bianco / tortora

schede tecniche
technical details

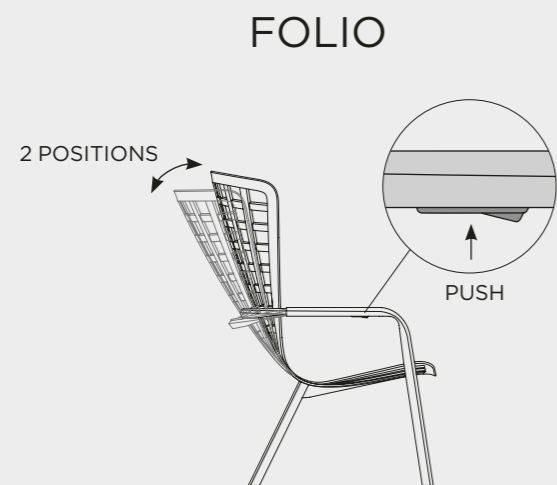

FOLIO ROCKING

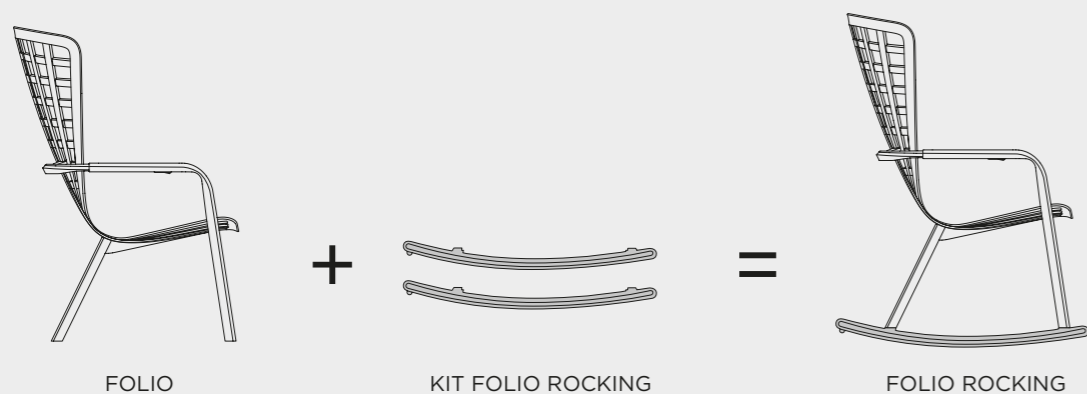

FOLIO è una innovativa poltrona relax a due posizioni pensata per l'outdoor, proposta su base fissa, con poggiatesta, oppure nella romantica versione a dondolo. L'ampia scocca della poltrona è costituita da un unico foglio dal design sapientemente curvato in modo da permettere il movimento tra seduta e schienale sfruttando l'elasticità del materiale senza l'ausilio di elementi di congiunzione o di rotazione.

FOLIO is an innovative relaxing armchair, adjusting to two positions, designed for outdoor use. It is available with a fixed base and a footrest, or in a romantic rocking version. The large structure of the armchair is made from a single perforated sheet. It has an expertly curved design that allows movement between the seat and back, exploiting the flexibility of the material without requiring any linking or rotating elements.

FOLIO

polipropilene fiberglass

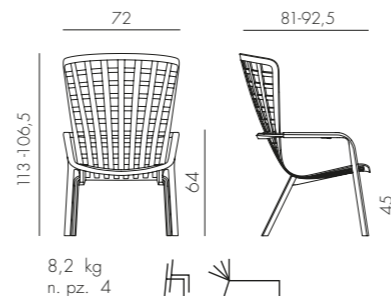

KIT FOLIO ROCKING

polipropilene fiberglass

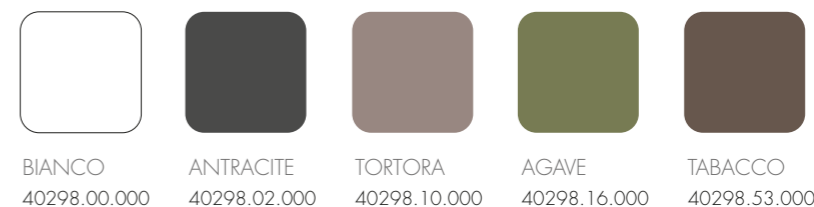
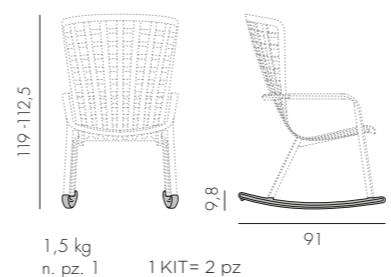

POGGIO

polipropilene fiberglass

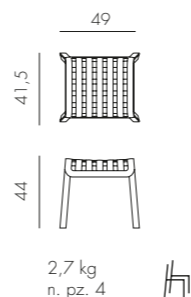

CUSCINO FOLIO COMFORT

tessuto

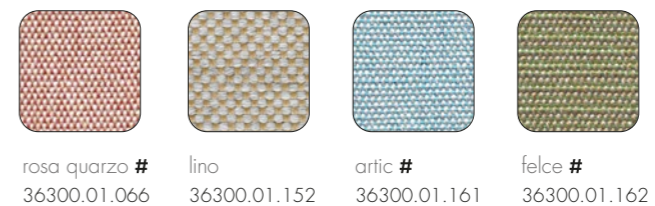
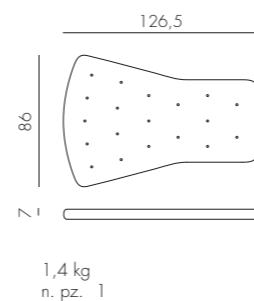

Variazioni di colore sono da ritenersi standard e naturali nei tessuti acrilici tinto filo. Posizionare in zone d'ombra - Colour variations are to be considered standard and natural in yarn-dyed acrylic fabrics. Position in shaded areas - Les variations de couleur des tissus acryliques au fil teint sont standard et naturelles. Placer dans des zones ombragées - Farbveränderungen sind als Standard und in im Garn gefärbten Acrylgeweben als natürlich zu betrachten. In schattigen Bereichen aufstellen - Las variaciones de color son normales y naturales en las telas acrílicas teñidas en hilo. Colocar en zonas de sombra - As variações de cor são consideradas standard e naturais nos tecidos acrílico tingidos com fio. Posicionar em zonas de sombra - Boyalı akrilik iplik kumaşlarda renk değişiklikleri standart ve doğal kabul edilir. Gölge alanlara yerleştiriniz - Изменения цвета следует считать нормой, они являются естественными в случае акриловых тканей с окрашенными волокнами. Размещать в тени

KOMODO

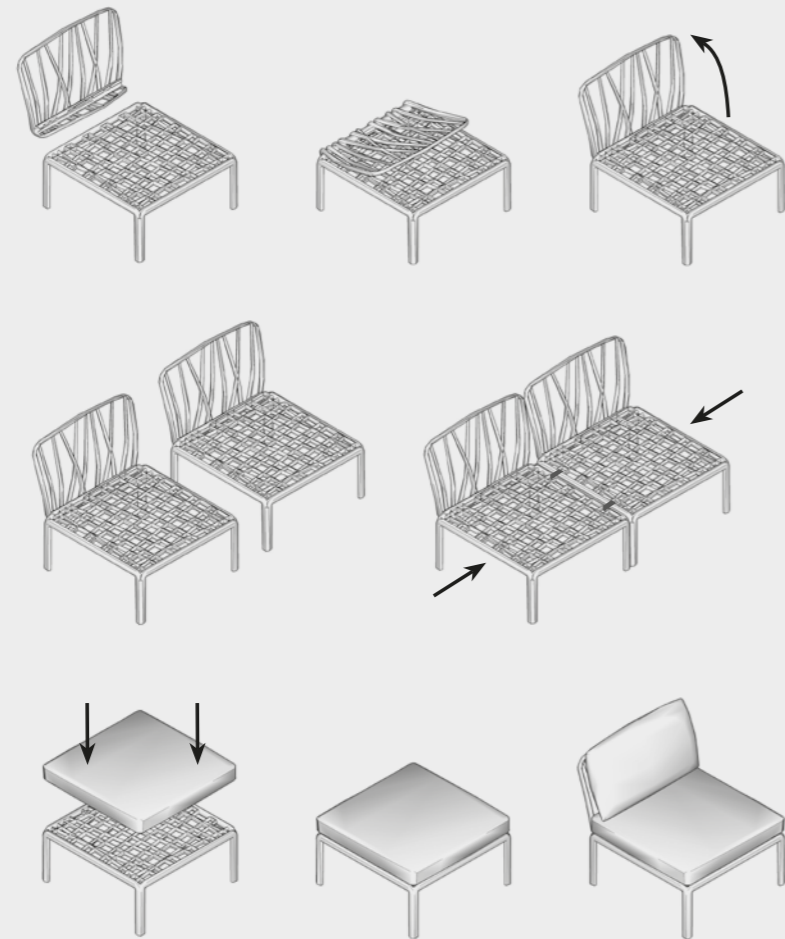

KOMODO è un sistema modulare di sedute configurabile a piacere. I moduli possono essere fissati tra loro e gli schienali e i braccioli sono agganciabili su tutti i lati della seduta. Oltre alla versione standard KOMODO 5, è possibile configurare e ordinare la tua versione personalizzata elencando tutti i singoli elementi che la formano.

KOMODO is a modular system of upholstered seats which can be configured to suit your particular needs. The modules can be secured to one another and the backrests and armrests can be attached on all sides of the seat.

In addition to the standard KOMODO 5 version, you can configure and order your own customized version simply by listing all the individual elements you require.

KOMODO POLTRONA

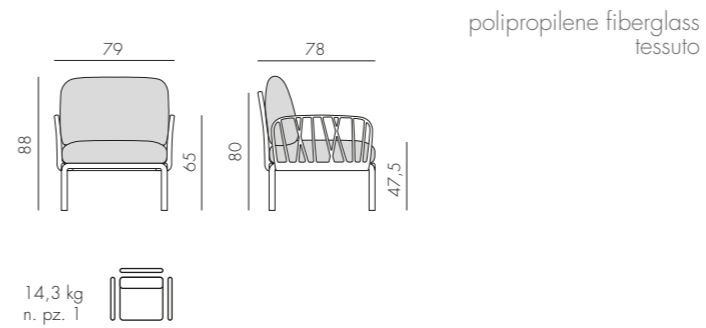

KOMODO ELEMENTO TERMINALE DX/SX

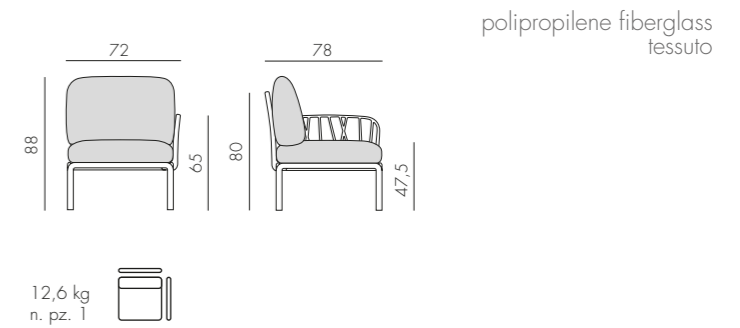

KOMODO ELEMENTO CENTRALE

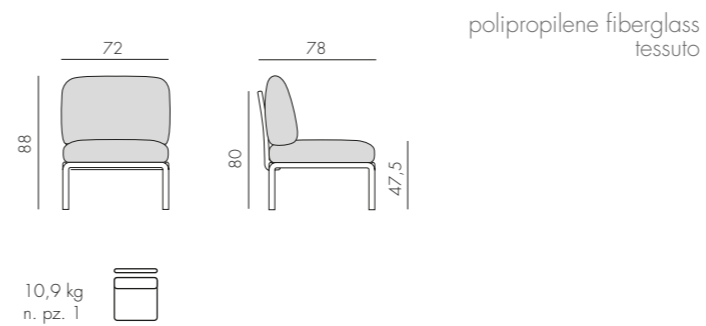

KOMODO ELEMENTO ANGOLO

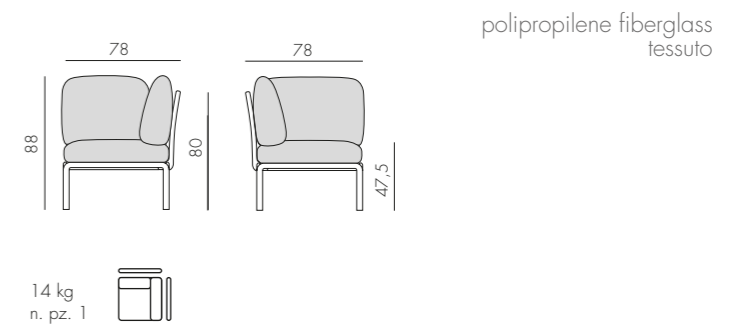

KOMODO POUF



KOMODO 5

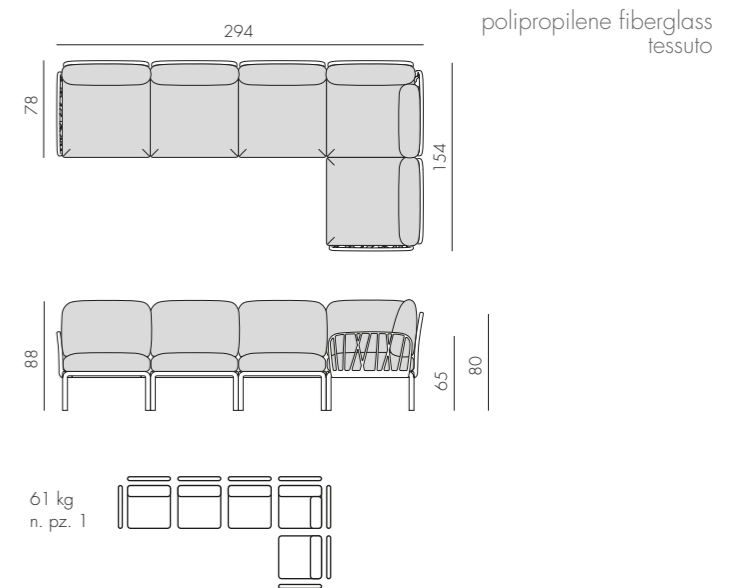

Life Cycle Assessment

For more information visit www.nardioutdoor.com/sustainability



	POLTRONA	ELEMENTO TERMINALE DX/SX	ELEMENTO CENTRALE	ELEMENTO ANGOLO	POUF	KOMODO 5	
BIANCO rosa quarzo #		40371.00.066	40372.00.066	40373.00.066	40374.00.066	40369.00.066	40370.00.066
ANTRACITE rosa quarzo #		40371.02.066	40372.02.066	40373.02.066	40374.02.066	40369.02.066	40370.02.066
TORTORA rosa quarzo #		40371.10.066	40372.10.066	40373.10.066	40374.10.066	40369.10.066	40370.10.066
AGAVE rosa quarzo #		40371.16.066	40372.16.066	40373.16.066	40374.16.066	40369.16.066	40370.16.066
BIANCO grigio komodo		40371.00.172	40372.00.172	40373.00.172	40374.00.172	40369.00.172	40370.00.172
ANTRACITE grigio komodo		40371.02.172	40372.02.172	40373.02.172	40374.02.172	40369.02.172	40370.02.172
TORTORA grigio komodo		40371.10.172	40372.10.172	40373.10.172	40374.10.172	40369.10.172	40370.10.172
AGAVE grigio komodo		40371.16.172	40372.16.172	40373.16.172	40374.16.172	40369.16.172	40370.16.172

Variazioni di colore sono da ritenersi standard e naturali nei tessuti acrilici tinto filo. Posizionare in zone d'ombra - Colour variations are to be considered standard and natural in yarn-dyed acrylic fabrics. Position in shaded areas - Les variations de couleur des tissus acryliques au fil teint sont standard et naturelles. Placer dans des zones ombragées - Farbveränderungen sind als Standard und in im Garn gefärbten Acrylgeweben als natürlich zu betrachten. In schattigen Bereichen aufstellen - Las variaciones de color son normales y naturales en las telas acrílicas teñidas en hilo. Colocar en zonas de sombra - As variações de cor são consideradas standard e naturais nos tecidos acrílico tingidos com fio. Posicionar em zonas de sombra - Boyalı akrilik iplik kumaşlarda renk değişiklikleri standart ve doğal kabul edilir. Gölge alanlara yerleştiriniz - Изменения цвета следует считать нормой, они являются естественными в случае акриловых тканей с окрашенными волокнами. Размещать в тени



	POLTRONA	ELEMENTO TERMINALE DX/SX	ELEMENTO CENTRALE	ELEMENTO ANGOLO	POUF	KOMODO 5	
BIANCO adriatic Sunbrella® *		40371.00.142	40372.00.142	40373.00.142	40374.00.142	40369.00.142	40370.00.142
ANTRACITE adriatic Sunbrella® *		40371.02.142	40372.02.142	40373.02.142	40374.02.142	40369.02.142	40370.02.142
TORTORA adriatic Sunbrella® *		40371.10.142	40372.10.142	40373.10.142	40374.10.142	40369.10.142	40370.10.142
AGAVE adriatic Sunbrella® *		40371.16.142	40372.16.142	40373.16.142	40374.16.142	40369.16.142	40370.16.142
BIANCO ghiaccio Sunbrella® *		40371.00.138	40372.00.138	40373.00.138	40374.00.138	40369.00.138	40370.00.138
ANTRACITE ghiaccio Sunbrella® *		40371.02.138	40372.02.138	40373.02.138	40374.02.138	40369.02.138	40370.02.138
TORTORA ghiaccio Sunbrella® *		40371.10.138	40372.10.138	40373.10.138	40374.10.138	40369.10.138	40370.10.138
AGAVE ghiaccio Sunbrella® *		40371.16.138	40372.16.138	40373.16.138	40374.16.138	40369.16.138	40370.16.138

* Trattamento laminato su richiesta con quantità minima - Laminated finish available on request with a minimum quantity - Traitement laminé sur demande avec une quantité minimum - Laminierter Ausrüstung auf Anfrage mit einer Mindestmenge - Tratamiento laminado bajo pedido con una cantidad mínima - Tratamento laminado sob encomenda com quantidade mínima - Talep üzerine minimum miktarda lamine işlem - Ламинированная обработка по запросу с минимальным количеством



	POLTRONA	ELEMENTO TERMINALE DX/SX	ELEMENTO CENTRALE	ELEMENTO ANGOLO	POUF	KOMODO 5
BIANCO avocado Sunbrella® *		40371.00.139	40372.00.139	40373.00.139	40374.00.139	40369.00.139 40370.00.139
ANTRACITE avocado Sunbrella® *		40371.02.139	40372.02.139	40373.02.139	40374.02.139	40369.02.139 40370.02.139
TORTORA avocado Sunbrella® *		40371.10.139	40372.10.139	40373.10.139	40374.10.139	40369.10.139 40370.10.139
AGAVE avocado Sunbrella® *		40371.16.139	40372.16.139	40373.16.139	40374.16.139	40369.16.139 40370.16.139
BIANCO giungla Sunbrella® *		40371.00.140	40372.00.140	40373.00.140	40374.00.140	40369.00.140 40370.00.140
ANTRACITE giungla Sunbrella® *		40371.02.140	40372.02.140	40373.02.140	40374.02.140	40369.02.140 40370.02.140
TORTORA giungla Sunbrella® *		40371.10.140	40372.10.140	40373.10.140	40374.10.140	40369.10.140 40370.10.140
AGAVE giungla Sunbrella® *		40371.16.140	40372.16.140	40373.16.140	40374.16.140	40369.16.140 40370.16.140

* Trattamento laminato su richiesta con quantità minima - Laminated finish available on request with a minimum quantity - Traitement laminé sur demande avec une quantité minimum - Lamierte Ausrüstung auf Anfrage mit einer Mindestmenge - Tratamiento laminado bajo pedido con una cantidad mínima - Tratamento laminado sob encomenda com quantidade mínima - Talep üzerine minimum miktarda lamine işlem - Ламинированная обработка по запросу с минимальным количеством



	POLTRONA	ELEMENTO TERMINALE DX/SX	ELEMENTO CENTRALE	ELEMENTO ANGOLO	POUF	KOMODO 5
BIANCO canvas Sunbrella® *		40371.00.141	40372.00.141	40373.00.141	40374.00.141	40369.00.141 40370.00.141
ANTRACITE canvas Sunbrella® *		40371.02.141	40372.02.141	40373.02.141	40374.02.141	40369.02.141 40370.02.141
TORTORA canvas Sunbrella® *		40371.10.141	40372.10.141	40373.10.141	40374.10.141	40369.10.141 40370.10.141
AGAVE canvas Sunbrella® *		40371.16.141	40372.16.141	40373.16.141	40374.16.141	40369.16.141 40370.16.141
BIANCO TECH panama		40371.00.131	40372.00.131	40373.00.131	40374.00.131	40369.00.131 40370.00.131
ANTRACITE TECH panama		40371.02.131	40372.02.131	40373.02.131	40374.02.131	40369.02.131 40370.02.131
TORTORA TECH panama		40371.10.131	40372.10.131	40373.10.131	40374.10.131	40369.10.131 40370.10.131
AGAVE TECH panama		40371.16.131	40372.16.131	40373.16.131	40374.16.131	40369.16.131 40370.16.131

* Trattamento laminato su richiesta con quantità minima - Laminated finish available on request with a minimum quantity - Traitement laminé sur demande avec une quantité minimum - Lamierte Ausrüstung auf Anfrage mit einer Mindestmenge - Tratamiento laminado bajo pedido con una cantidad mínima - Tratamento laminado sob encomenda com quantidade mínima - Talep üzerine minimum miktarda lamine işlem - Ламинированная обработка по запросу с минимальным количеством

Tessuti disponibili su ordinazione per minimi quantitativi d'ordine - Fabrics available to order for minimum order quantities - Tissus disponibles sur commande de quantités minimales - Gewebe auf Bestellung für Mindestbestellmengen erhältlich - Telas disponibles bajo pedido para cantidades mínimas - Tecidos disponíveis por encomenda para quantidades mínimas de encomenda - Minimum sipariş miktarına göre sipari verilebilecek mevcut kumaşlar - ткани на заказ для минимального объема заказа.

Sunbrella®
EXTRA *

pp. 176

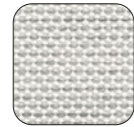

marble
Sunbrella® .186

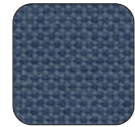

blue storm
Sunbrella® .185



alpine
Sunbrella® .182



mink brown
Sunbrella® .183

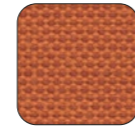

pumpkin
Sunbrella® .184

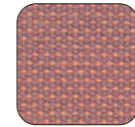

opera
Sunbrella® .187

Nardi
Acrilici/Acrylic #

pp. 174

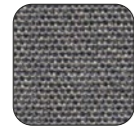

grey stone .064

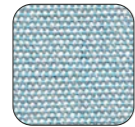

artic .161

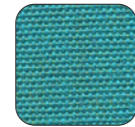

sardinia .072

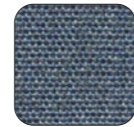

denim .070

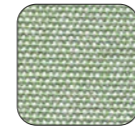

the verde .071



lime .061



felce .162



senape .069



cherry .065

Variazioni di colore sono da ritenersi standard e naturali nei tessuti acrilici tinto filo. Posizionare in zone d'ombra - Colour variations are to be considered standard and natural in yarn-dyed acrylic fabrics. Position in shaded areas - Les variations de couleur des tissus acryliques au fil teint sont standard et naturelles. Placer dans des zones ombragées - Farbveränderungen sind als Standard und in im Garn gefärbten Acrylgeweben als natürlich zu betrachten. In schattigen Bereichen aufstellen - Las variaciones de color son normales y naturales en las telas acrílicas teñidas en hilo. Colocar en zonas de sombra - As variações de cor são consideradas standard e naturais nos tecidos acrílico tingidos com fio. Posicionar em zonas de sombra - Boyalı akrilik iplik kumaşlarda renk değişiklikleri standart ve doğal kabul edilir. Gölgeli alanlara yerleştiriniz - Изменения цвета следует считать нормой, они являются естественными в случае акриловых тканей с окрашенными волокнами. Размещать в тени

* Trattamento laminato su richiesta con quantità minima - Laminated finish available on request with a minimum quantity - Traitement laminé sur demande avec une quantité minimum - Laminierte Ausrüstung auf Anfrage mit einer Mindestmenge - Tratamiento laminado bajo pedido con una cantidad mínima - Tratamento laminado sob encomenda com quantidade mínima - Talep üzerine minimum miktarda lamine işlem - Ламинированная обработка по запросу с минимальным количеством

KOMODO TAVOLINO

polipropilene fiberglass

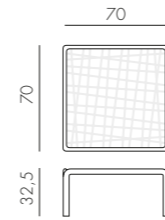

6,7 kg
n. pz. 1



BIANCO
40378.00.000



ANTRACITE
40378.02.000



TORTORA
40378.10.000



AGAVE
40378.16.000

KOMODO TAVOLINO VETRO

polipropilene fiberglass
vetro

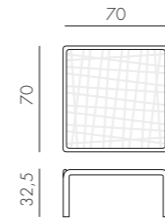

11,4 kg
n. pz. 1



BIANCO
vetro
40368.00.501



ANTRACITE
vetro
40368.02.501



TORTORA
vetro
40368.10.501



AGAVE
vetro
40368.16.501

KOMODO OMBRA 3 **new**

polipropilene fiberglass
tessuto

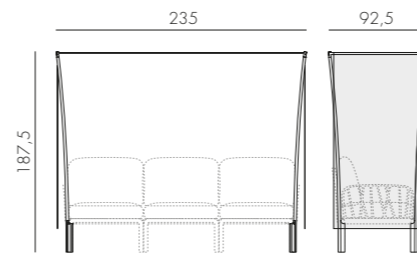

2,9 kg
n. pz. 1



BIANCO
velo white
40408.00.203



ANTRACITE
velo white
40408.02.203



TORTORA
velo white
40408.10.203



AGAVE
velo white
40408.16.203

KOMODO OMBRA 2 **new**

polipropilene fiberglass
tessuto

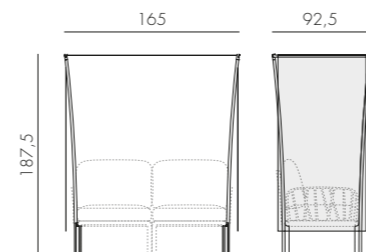

2,8 kg
n. pz. 1



BIANCO
velo white
40407.00.203



ANTRACITE
velo white
40407.02.203

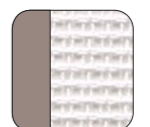

TORTORA
velo white
40407.10.203



AGAVE
velo white
40407.16.203

KOMODO BRACCIOLO

polipropilene fiberglass

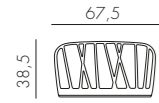

1,7 kg
n. pz. 2



BIANCO
40375.00.000

ANTRACITE
40375.02.000

TORTORA
40375.10.000

AGAVE
40375.16.000

KOMODO SCHIENALE

polipropilene fiberglass

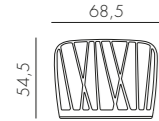

2 kg
n. pz. 4



BIANCO
40376.00.000

ANTRACITE
40376.02.000

TORTORA
40376.10.000

AGAVE
40376.16.000

CUSCINO SCHIENALE KOMODO

tessuto

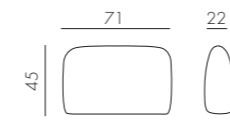

1,4 kg
n. pz. 1

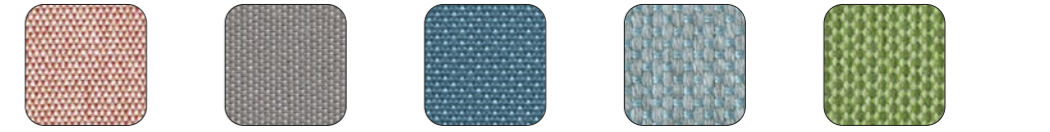

rosa quarzo #
36370.52.066

grigio komodo
36370.52.163

adriatic Sunbrella®*
36370.52.142

ghiaccio Sunbrella®*
36370.52.138

avocado Sunbrella®*
36370.52.139



giungla Sunbrella®*
36370.52.140

canvas Sunbrella®*
36370.52.141

TECH panama
36370.52.131

Sunbrella® EXTRA ▲
pp. 176

Nardi Acrilici/Acrylic ▲
pp. 174

CUSCINO SCHIENALE ANGOLO KOMODO

tessuto

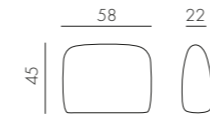

1,1 kg
n. pz. 1

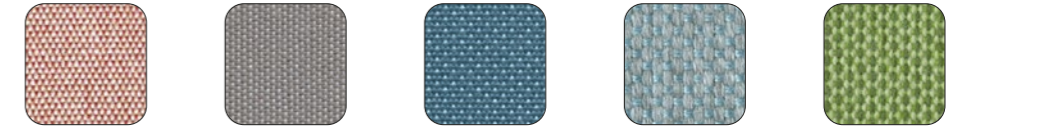

rosa quarzo #
36370.54.066

grigio komodo
36370.54.163

adriatic Sunbrella®*
36370.54.142

ghiaccio Sunbrella®*
36370.54.138

avocado Sunbrella®*
36370.54.139



giungla Sunbrella®*
36370.54.140

canvas Sunbrella®*
36370.54.141

TECH panama
36370.54.131

Sunbrella® EXTRA ▲
pp. 176

Nardi Acrilici/Acrylic ▲
pp. 174

▲ Sunbrella® EXTRA - pp. 176 Nardi Acrilici/Acrylic - pp. 174

Tessuti disponibili su ordinazione per minimi quantitativi d'ordine - Fabrics available to order for minimum order quantities - Tissus disponibles sur commande de quantités minimales - Gewebe auf Bestellung für Mindestbestellmengen erhältlich - Telas disponibles bajo pedido para cantidades mínimas - Tecidos disponíveis por encomenda para quantidades mínimas de encomenda - Minimum sipariş miktarına göre sipariş verilebilecek mevcut kumaşlar - ткани на заказ для минимального объема заказа.

Variazioni di colore sono da ritenersi standard e naturali nei tessuti acrilici tinto filo. Posizionare in zone d'ombra - Colour variations are to be considered standard and natural in yarn-dyed acrylic fabrics. Position in shaded areas - Les variations de couleur des tissus acryliques au fil teint sont standard et naturelles. Placer dans des zones ombragées - Farbveränderungen sind als Standard und in im Garn gefärbten Acrylgeweben als natürlich zu betrachten. In schattigen Bereichen aufstellen - Las variaciones de color son normales y naturales en las telas acrílicas teñidas en hilo. Colocar en zonas de sombra - As variações de cor são consideradas standard e naturais nos tecidos acrílico tingidos com fio. Posicionar em zonas de sombra - Boyalı akrilik iplik kumaşlarda renk değişiklikleri standart ve doğal kabul edilir. Gölge alanlara yerleştiriniz - Изменения цвета следует считать нормой, они являются естественными в случае акриловых тканей с окрашенными волокнами. Размещать в тени

* Trattamento laminato su richiesta con quantità minima - Laminated finish available on request with a minimum quantity - Traitement laminé sur demande avec une quantité minimum - Lamierte Ausrüstung auf Anfrage mit einer Mindestmenge - Tratamiento laminado bajo pedido con una cantidad mínima - Tratamiento laminado sob encomenda com quantidade mínima - Talep üzerine minimum miktarda lamine işlem - Ламинированная обработка по запросу с минимальным количеством

DOGA RELAX **new**

polipropilene fiberglass

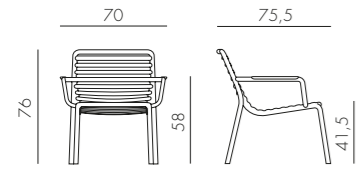

6,1 kg
n. pz. 4



BIANCO 40256.00.000 ANTRACITE 40256.02.000 CAPPUCCINO 40256.14.000 MENTA 40256.15.000 AGAVE 40256.16.000 PERA 40256.18.000



MARSALA 40256.21.000 TABACCO 40256.53.000

DOGA BISTROT **new**

polipropilene fiberglass

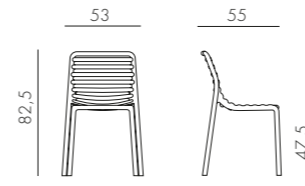

4 kg
n. pz. 6



BIANCO 40255.00.000 ANTRACITE 40255.02.000 CAPPUCCINO 40255.14.000 MENTA 40255.15.000 AGAVE 40255.16.000 PERA 40255.18.000



MARSALA 40255.21.000 TABACCO 40255.53.000

DOGA ARMCHAIR **new**

polipropilene fiberglass

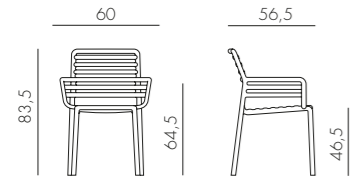

4,8 kg
n. pz. 6



BIANCO 40254.00.000 ANTRACITE 40254.02.000 CAPPUCCINO 40254.14.000 MENTA 40254.15.000 AGAVE 40254.16.000 PERA 40254.18.000



MARSALA 40254.21.000 TABACCO 40254.53.000

TRILL ARMCHAIR



polipropilene fiberglass

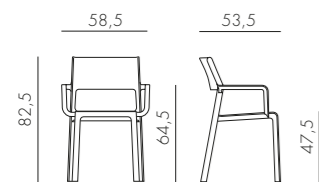

4,7 kg
n. pz. 6



BIANCO 40250.00.000 ANTRACITE 40250.02.000 GRIGIO 40250.03.000
ROSA BOUQUET 40250.08.000 TORTORA 40250.10.000 AGAVE 40250.16.000



OTTANIO 40250.49.000 TABACCO 40250.53.000
SENAPE 40250.56.000

TRILL BISTROT

polipropilene fiberglass

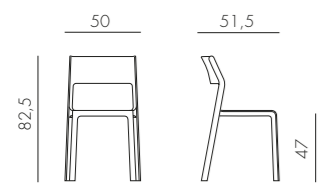

4,2 kg
n. pz. 6



BIANCO 40253.00.000 ANTRACITE 40253.02.000 GRIGIO 40253.03.000
ROSA BOUQUET 40253.08.000 TORTORA 40253.10.000 AGAVE 40253.16.000



OTTANIO 40253.49.000 TABACCO 40253.53.000
SENAPE 40253.56.000

TRILL STOOL

polipropilene fiberglass

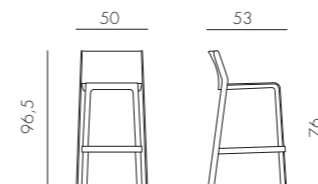

5,1 kg
n. pz. 4



BIANCO 40350.00.000 ANTRACITE 40350.02.000 GRIGIO 40350.03.000
ROSA BOUQUET 40350.08.000 TORTORA 40350.10.000 AGAVE 40350.16.000



OTTANIO 40350.49.000 TABACCO 40350.53.000
SENAPE 40350.56.000

TRILL STOOL MINI

polipropilene fiberglass

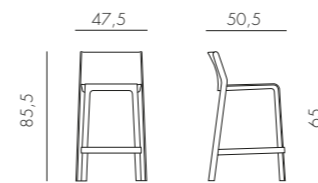

4,8 kg
n. pz. 4



BIANCO 40353.00.000 ANTRACITE 40353.02.000 GRIGIO 40353.03.000
ROSA BOUQUET 40353.08.000 TORTORA 40353.10.000 AGAVE 40353.16.000



OTTANIO 40353.49.000 TABACCO 40353.53.000
SENAPE 40353.56.000



Life Cycle Assessment

For more information visit www.nardioutdoor.com/sustainability

NET BENCH

polipropilene fiberglass

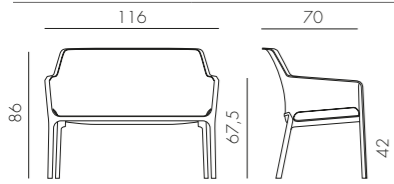

8,9 kg
n. pz. 20



BIANCO 40338.00.000 ANTRACITE 40338.02.000 SALICE 40338.04.000 TORTORA 40338.10.000 SENAPE 40338.56.000 CORALLO 40338.75.000

NET RELAX

polipropilene fiberglass

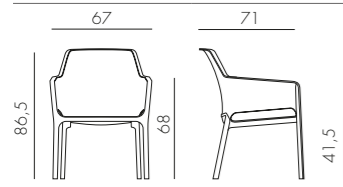

4,9 kg
n. pz. 4



pz. 6

BIANCO 40327.00.000 ANTRACITE 40327.02.000 SALICE 40327.04.000 TORTORA 40327.10.000 SENAPE 40327.56.000 CORALLO 40327.75.000

NET

polipropilene fiberglass

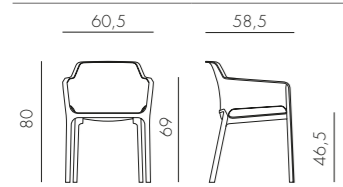

3,9 kg
n. pz. 6



pz. 6

BIANCO 40326.00.000.06 ANTRACITE 40326.02.000.06 SALICE 40326.04.000.06 TORTORA 40326.10.000.06 SENAPE 40326.56.000.06 CORALLO 40326.75.000.06

BIT

polipropilene fiberglass

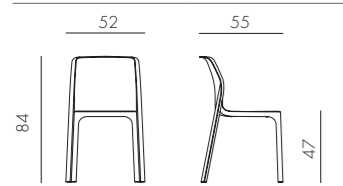

3,5 kg
n. pz. 6



BIANCO 40328.00.000.06 ANTRACITE 40328.02.000.06 SALICE 40328.04.000.06 TORTORA 40328.10.000.06 SENAPE 40328.56.000.06 CORALLO 40328.75.000.06

NET STOOL

polipropilene fiberglass

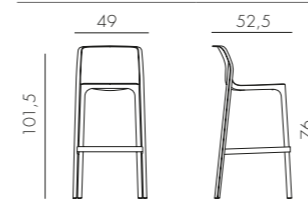

4,4 kg
n. pz. 4



BIANCO 40355.00.000 ANTRACITE 40355.02.000 SALICE 40355.04.000 TORTORA 40355.10.000 SENAPE 40355.56.000 CORALLO 40355.75.000

NET STOOL MINI

polipropilene fiberglass

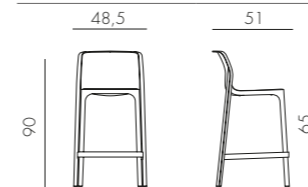

4,2 kg
n. pz. 4



BIANCO 40356.00.000 ANTRACITE 40356.02.000 SALICE 40356.04.000 TORTORA 40356.10.000 SENAPE 40356.56.000 CORALLO 40356.75.000

PALMA

polipropilene

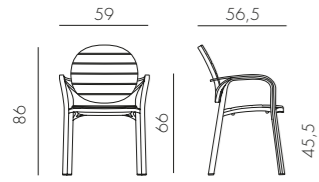

5,2 kg
n. pz. 6



BIANCO 40237.00.000
BIANCO TORTORA 40237.00.010
ANTRACITE 40237.02.002
CAFFÈ 40237.05.005
TORTORA 40237.10.010

ERICA

polipropilene

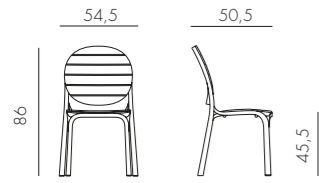

4,2 kg
n. pz. 22



BIANCO 40236.00.000
BIANCO TORTORA 40236.00.010
ANTRACITE 40236.02.002
CAFFÈ 40236.05.005
TORTORA 40236.10.010

NINFEA DINNER

polipropilene
alluminio

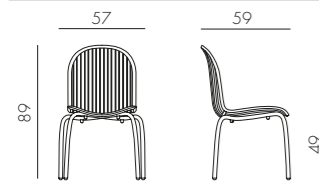

4,5 kg
n. pz. 6



ANTRACITE vernic. antracite 62052.02.000
BIANCO vernic. bianco 62053.00.000

NINFEA RELAX

polipropilene
alluminio

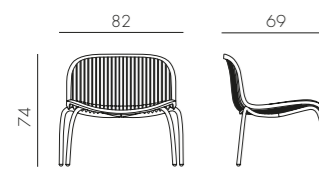

7,2 kg
n. pz. 2



ANTRACITE vernic. antracite 62252.02.000
BIANCO vernic. bianco 62253.00.000

ARIA (POLTRONA ARIA + CUSCINO SEDUTA + CUSCINO ARREDO)

polipropilene
tessuto

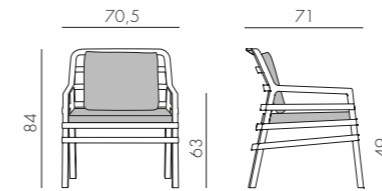

7,9 kg
n. pz. 1

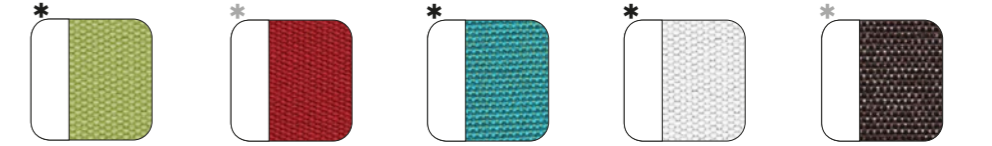

BIANCO lime # 40330.00.061.061
BIANCO cherry # 40330.00.065.065
BIANCO sardinia # 40330.00.072.072
BIANCO bianco 40330.00.155.155
BIANCO caffè 40330.00.165.165

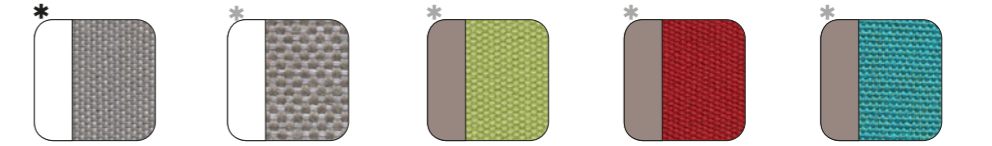

BIANCO grigio # 40330.00.163.163
BIANCO grigio Sunbrella® 40330.00.136.136
TORTORA lime # 40330.10.061.061
TORTORA cherry # 40330.10.065.065
TORTORA sardinia # 40330.10.072.072

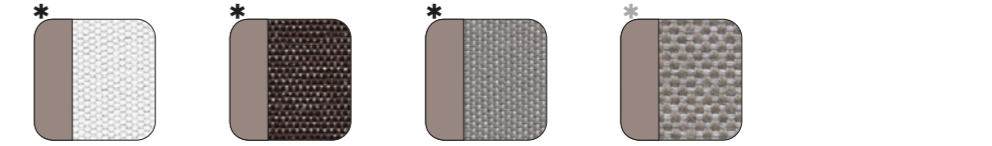

TORTORA bianco 40330.10.155.155
TORTORA caffè 40330.10.165.165
TORTORA grigio # 40330.10.163.163
TORTORA grigio Sunbrella® 40330.10.136.136

* Disponibile a magazzino
Available ex-stock
Disponibile sur stock
Ab Lager verfügbar
Disponibile en almacén habitualmente
Disponível em estoque
Stokta mevcut
Наличие на складе

* Disponibile su ordine
Available to order
Disponibile sur commande
Mit Auftrag verfügbar
Disponibile sólo sobre pedido
Disponível sob encomenda
Sipariş göre hazırlanacaktır
Под заказ

ARIA FIT (POLTRONA ARIA + CUSCINO SEDUTA + CUSCINO FIT)

polipropilene
tessuto

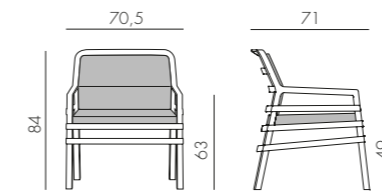

7,9 kg
n. pz. 1

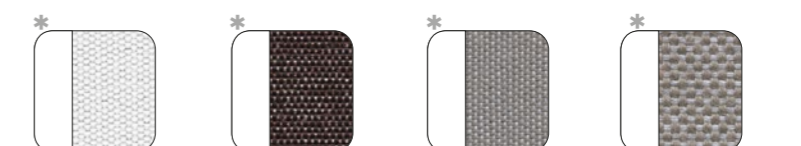

BIANCO bianco 40330.00.155.FIT
BIANCO caffè 40330.00.165.FIT
BIANCO grigio # 40330.00.163.FIT
BIANCO grigio Sunbrella® 40330.00.136.FIT

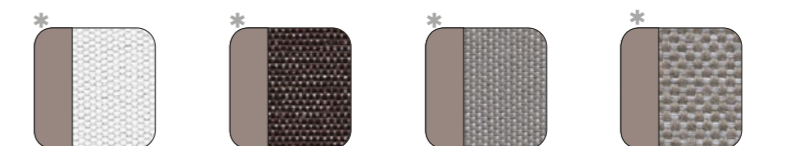

TORTORA bianco 40330.10.155.FIT
TORTORA caffè 40330.10.165.FIT
TORTORA grigio # 40330.10.163.FIT
TORTORA grigio Sunbrella® 40330.10.136.FIT

* Disponibile su ordine
Available to order
Disponibile sur commande
Mit Auftrag verfügbar
Disponibile sólo sobre pedido
Disponível sob encomenda
Sipariş göre hazırlanacaktır
Под заказ

Variazioni di colore sono da ritenersi standard e naturali nei tessuti acrilici tinto filo. Posizionare in zone d'ombra - Colour variations are to be considered standard and natural in yarn-dyed acrylic fabrics. Position in shaded areas - Les variations de couleur des tissus acryliques au fil teint sont standard et naturelles. Placer dans des zones ombragées - Farbveränderungen sind als Standard und in im Garn gefärbten Acrylgeweben als natürlich zu betrachten. In schattigen Bereichen aufstellen - Las variaciones de color son normales y naturales en las telas acrílicas teñidas en hilo. Colocar en zonas de sombra - As variações de cor são consideradas standard e naturais nos tecidos acrílico tingidos com fio. Posicionar em zonas de sombra - Boyalı akrilik iplik kumaşlarda renk değişiklikleri standart ve doğal kabul edilir. Gölge alanlara yerleştiriniz - Изменения цвета следует считать нормой, они являются естественными в случае акриловых тканей с окрашенными волокнами. Размещать в тени

ATLANTICO

polipropilene fiberglass
tessuto sintetico

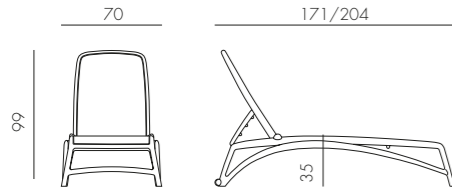

16 kg
n. pz. 20

Tessuto ricambiabile
Replaceable fabric
Tissu changeable
Auswechselbarer Stoff
Tela sustituible
Tecidos recambiables
Değiştirilebilen Kumaş
Съемная ткань

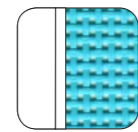

BIANCO
celeste
40450.00.075

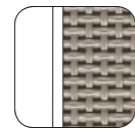

BIANCO
tortora
40450.00.104

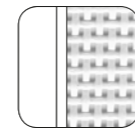

BIANCO
bianco
40450.00.107



ANTRACITE
antracite
40450.02.057

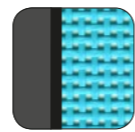

ANTRACITE
celeste
40450.02.075



CAFFÈ
celeste
40450.05.075



CAFFÈ
tortora
40450.05.104

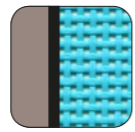

TORTORA
celeste
40450.10.075



TORTORA
tortora
40450.10.104

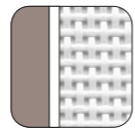

TORTORA
bianco
40450.10.107

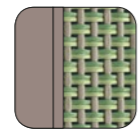

TORTORA
agave
40450.10.101

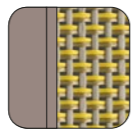

TORTORA
deserto
40450.10.103

RICAMBIO ATLANTICO

resina acetlica
tessuto sintetico

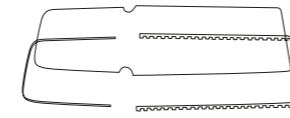

1,3 kg
n. pz. 1

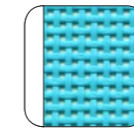

celeste
40460.00.075

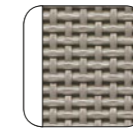

tortora
40460.00.104

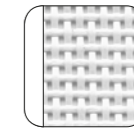

bianco
40460.00.107

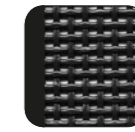

antracite
40460.01.057



celeste
40460.01.075



tortora
40460.01.104

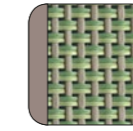

agave
40460.10.101

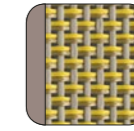

deserto
40460.10.103

BRACCIOLO ATLANTICO

polipropilene fiberglass

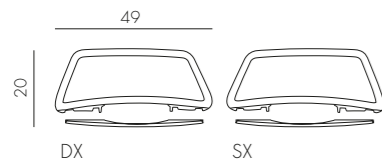

1,1 kg
n. pz. 1

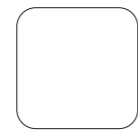

BIANCO
40452.00.000



ANTRACITE
40452.02.000



CAFFÈ
40452.05.000



TORTORA
40452.10.000

RIO - RIO ALU

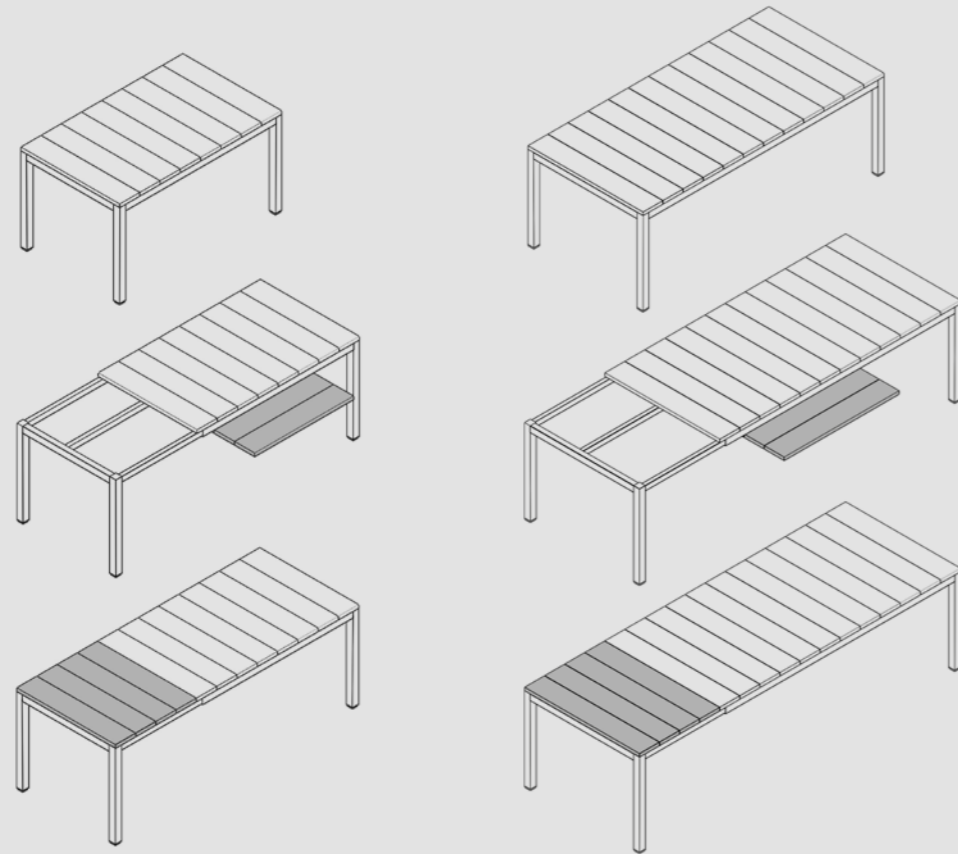

rio 140 extensible
6/8 🧑 140/210x85x76 cm

rio Alu 140 extensible
6/8 🧑 140/210x85x75 cm

rio 210 extensible
8/10 🧑 210/280x100x76 cm

rio Alu 210 extensible
8/10 🧑 210/280x100x75 cm

RIO ALU 210 EXTENSIBLE 8/10 🧑

alluminio

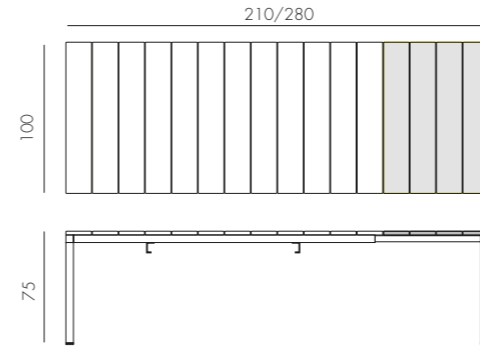

54 kg
n. pz. 1

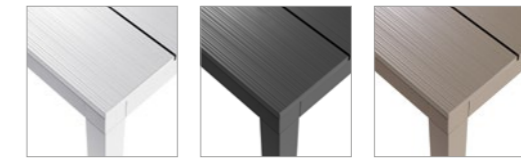

verniciato bianco
48853.00.000

verniciato antracite
48852.02.000

verniciato tortora
48859.10.000

RIO ALU 140 EXTENSIBLE 6/8 🧑

alluminio

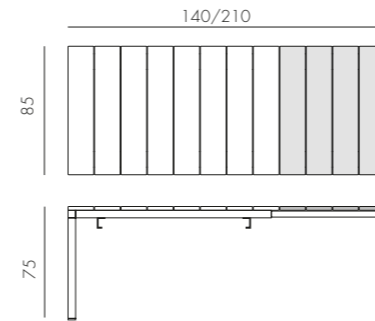

37,1 kg
n. pz. 1

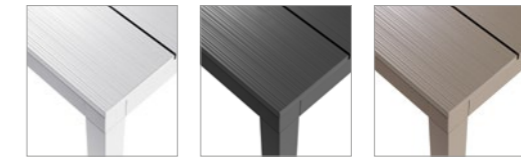

verniciato bianco
48653.00.000

verniciato antracite
48652.02.000

verniciato tortora
48659.10.000

SET RIO BENCH ALU **new**

alluminio

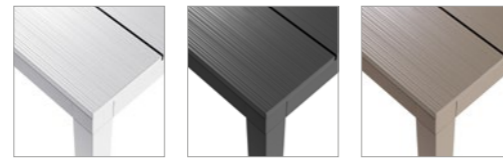
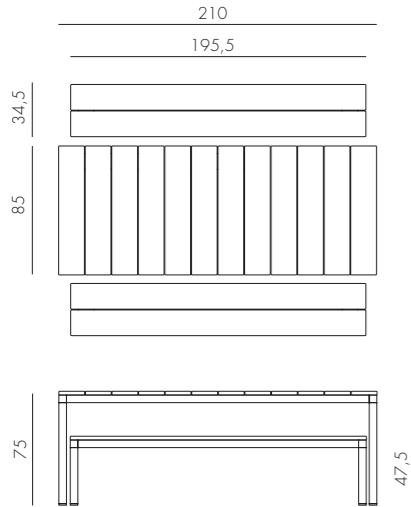

verniciato bianco 49253.00.000
verniciato antracite 49252.02.000
verniciato tortora 49259.10.000

72 kg
n. pz. 3

Il set comprende 1 Rio Alu 210 Fix e 2 Rio Bench Alu
The set includes 1 Rio Alu 210 Fix and 2 Rio Bench Alu
L'ensemble comprend 1 Rio Alu 210 Fix et 2 Rio Bench Alu
Die Garnitur umfasst 1 Rio Alu 210 Fix und 2 Rio Bench Alu

El juego incluye 1 Rio Alu 210 Fix y 2 Rio Bench Alu
O conjunto inclui 1 Rio Alu 210 Fix e 2 Rio Bench Alu
Set içeriğinde 1 Rio Alu 210 Fix ve 2 Rio Bench Alu mevcuttur
Комплект состоит из 1 Rio Alu 210 Fix и 2 Rio Bench Alu

RIO BENCH ALU **new**

alluminio

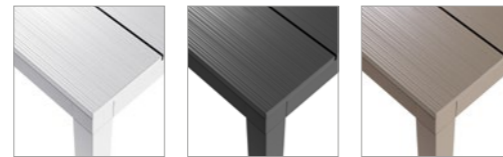
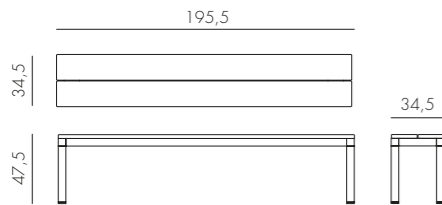

verniciato bianco 49053.00.000
verniciato antracite 49052.02.000
verniciato tortora 49059.10.000

17,5 kg
n. pz. 1

RIO ALU 210 FIX **new**

alluminio

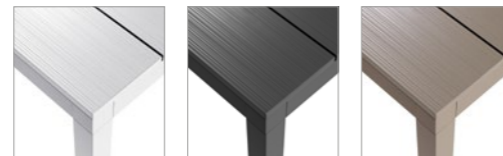
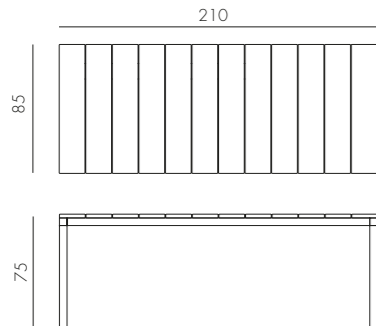

verniciato bianco 49153.00.000
verniciato antracite 49152.02.000
verniciato tortora 49159.10.000

37 kg
n. pz. 1

RIO 210 EXTENSIBLE 8/10

durelTOP - polipropilene
alluminio

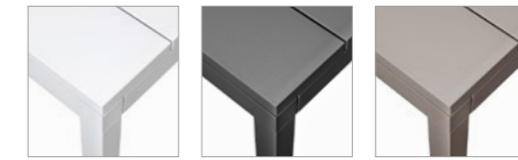
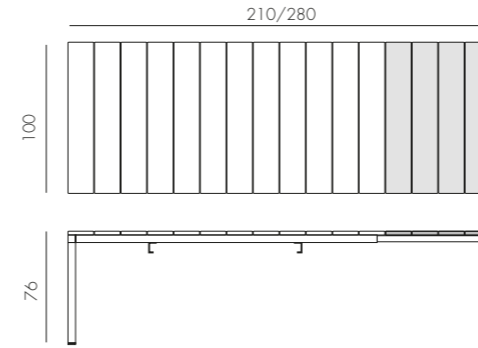

BIANCO verniciato bianco 48253.00.000
ANTRACITE* verniciato antracite 48252.02.000
TORTORA verniciato tortora 48259.10.000

49 kg
n. pz. 1

RIO 140 EXTENSIBLE 6/8

durelTOP - polipropilene
alluminio

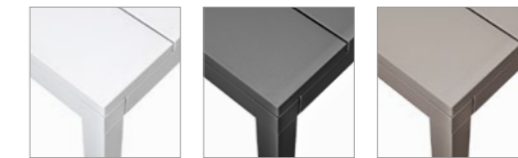
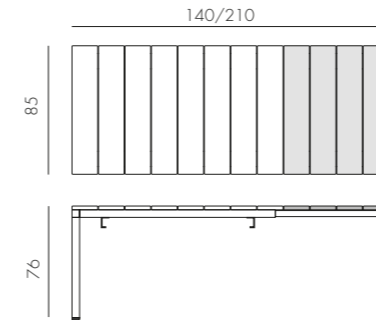

BIANCO verniciato bianco 48353.00.000
ANTRACITE* verniciato antracite 48352.02.000
TORTORA verniciato tortora 48359.10.000

32,6 kg
n. pz. 1

* Posizionare in zone d'ombra - Position in shaded areas - Placer dans des zones ombragées - In schattigen Bereichen aufstellen - Colocar en zonas de sombra - Posicionar em zonas de sombra - Gölge alanlara yerleştiriniz - Размещать в тени

ALLORO

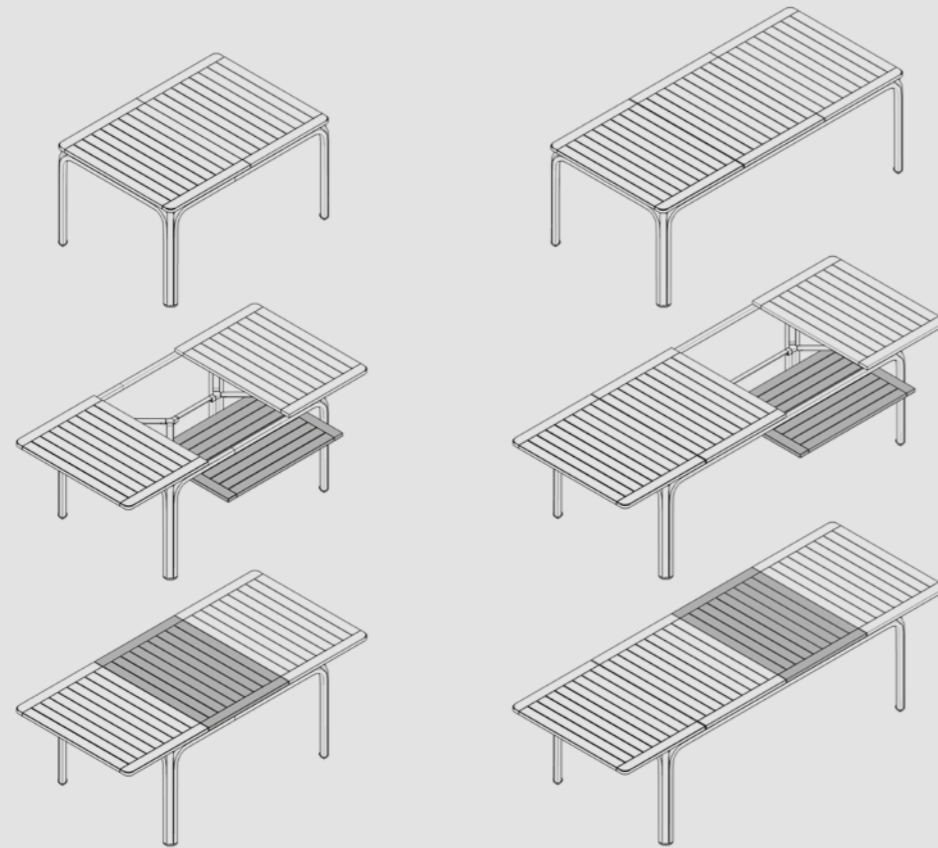

alloro 140 extensible
6/8 140/210x100x73 cm

alloro 210 extensible
8/10 210/280x100x73 cm

ALLORO 210 EXTENSIBLE 8/10

durelTOP - polipropilene
alluminio

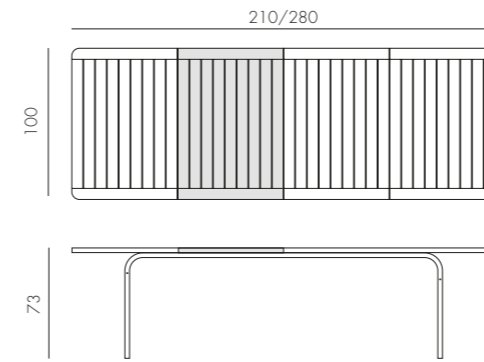

44,5 kg
n. pz. 1



BIANCO
verniciato bianco
42853.00.000

TORTORA
verniciato bianco
42853.10.000

ANTRACITE*
verniciato antracite
42852.02.000

TORTORA
verniciato tortora
42859.10.000

ALLORO 140 EXTENSIBLE 6/8

durelTOP - polipropilene
alluminio

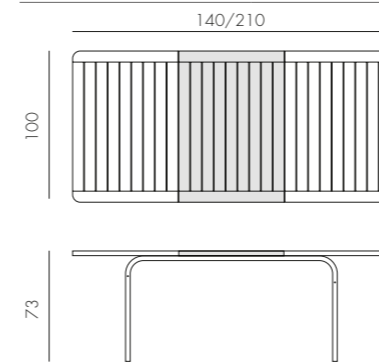

33,7 kg
n. pz. 1



BIANCO
verniciato bianco
42753.00.000

TORTORA
verniciato bianco
42753.10.000

ANTRACITE*
verniciato antracite
42752.02.000

TORTORA
verniciato tortora
42759.10.000

* Posizionare in zone d'ombra - Position in shaded areas - Placer dans des zones ombragées - In schattigen Bereichen aufstellen - Colocar en zonas de sombra - Posicionar em zonas de sombra - Gölge alanlara yerleştiriniz - Размещать в тени

LOTO DINNER 190

vetro
alluminio

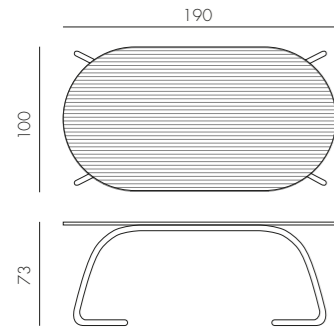

ANTRACITE
verniciato antracite
44052.02.000

BIANCO
verniciato bianco
44053.00.000

49,8 kg
n. pz. 1

LOTO DINNER Ø170

vetro
alluminio

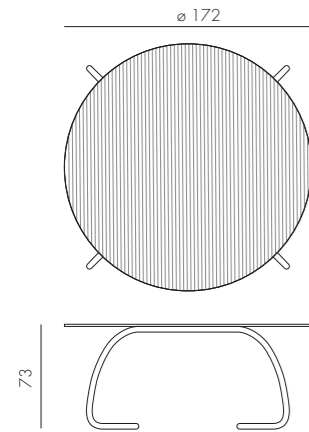

ANTRACITE
verniciato antracite
44452.02.000



BIANCO
verniciato bianco
44453.00.000

65,3 kg
n. pz. 1

LOTO RELAX 95

vetro
alluminio

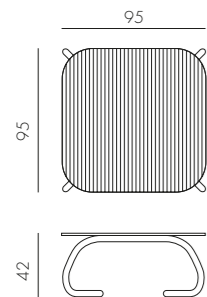

ANTRACITE
verniciato antracite
44752.02.000



BIANCO
verniciato bianco
44753.00.000

27 kg
n. pz. 1

LOTO RELAX 60

laminato
alluminio

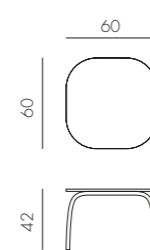

ANTRACITE *
verniciato antracite
44652.00.303



BIANCO
verniciato bianco
44653.00.301

5 kg
n. pz. 1

CUBE 140X80

durelTOP - polipropilene
alluminio

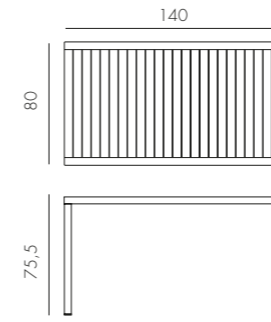

BIANCO
verniciato bianco
47753.00.000

ANTRACITE *
verniciato antracite
47752.02.000

CAFFÈ *
verniciato caffè
47757.05.000

TORTORA
verniciato tortora
47759.10.000

16,9 kg
n. pz. 1

CUBE 80

durelTOP - polipropilene
alluminio

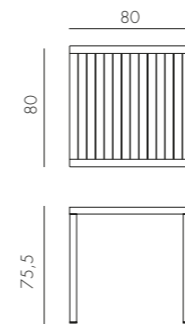

BIANCO
verniciato bianco
48053.00.000

ANTRACITE
verniciato antracite
48052.02.000

CAFFÈ
verniciato caffè
48057.05.000

TORTORA
verniciato tortora
48059.10.000

11,5 kg
n. pz. 1

CUBE 70

durelTOP - polipropilene
alluminio

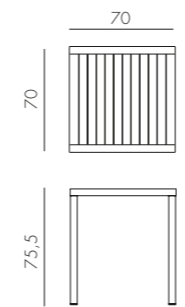

BIANCO
verniciato bianco
47853.00.000

ANTRACITE
verniciato antracite
47852.02.000

CAFFÈ
verniciato caffè
47857.05.000

TORTORA
verniciato tortora
47859.10.000

9,5 kg
n. pz. 1

* Posizionare in zone d'ombra - Position in shaded areas - Placer dans des zones ombragées - In schattigen Bereichen aufstellen - Colocar en zonas de sombra - Posicionar em zonas de sombra - Gölge alanlara yerleştiriniz - Размещать в тени

* Posizionare in zone d'ombra - Position in shaded areas - Placer dans des zones ombragées - In schattigen Bereichen aufstellen - Colocar en zonas de sombra - Posicionar em zonas de sombra - Gölge alanlara yerleştiriniz - Размещать в тени

DOGA TABLE **new**

polipropilene fiberglass

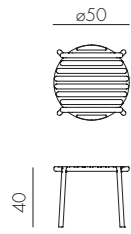

2,4 kg
n. pz. 4



BIANCO 40042.00.000 ANTRACITE 40042.02.000 CAPPUCCINO 40042.14.000 MENTA 40042.15.000 AGAVE 40042.16.000 PERA 40042.18.000



MARSALA 40042.21.000 TABACCO 40042.53.000

NET TABLE 100

polipropilene fiberglass

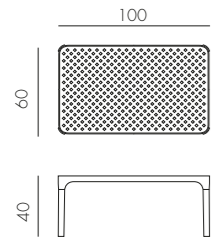

6,3 kg
n. pz. 1



BIANCO 40064.00.000 ANTRACITE 40064.02.000 SALICE 40064.04.000 TORTORA 40064.10.000 SENAPE 40064.56.000 CORALLO 40064.75.000

ARIA TAVOLINO 100

polipropilene

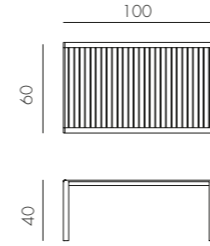

8 kg
n. pz. 1



BIANCO 40052.00.000 TORTORA 40052.10.000

ARIA TAVOLINO 60

polipropilene

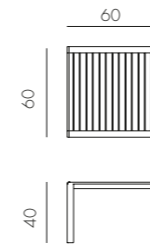

5 kg
n. pz. 1



BIANCO 40051.00.000 TORTORA 40051.10.000

POP

polipropilene fiberglass

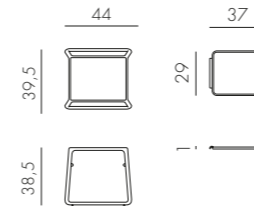

2,5 kg
n. pz. 4



BIANCO 40048.00.000 ANTRACITE 40048.02.000 CAFFÈ 40048.05.000 TORTORA 40048.10.000

regeneration

Our commitment to making environmentally sustainable products, with high added value led us to launch the Regeneration industrial programme, in 2019, for the production of outdoor furniture in recycled plastic.

We make our products at a production plant designed with cutting-edge plant engineering technology. It is equipped with energy-saving hybrid injection presses, with an air-based cooling system without using water and consuming very little electricity. Most of the electricity used is produced by a photovoltaic panel system.

Regeneration is much more than a simple line of recycled plastic products. It allows us to experiment with solutions that can be applied on a large scale to the entire production cycle and involves all steps, from the concept creation of individual furniture items to their packaging.

For the Regeneration line, all protective packaging and related internal supports are made of FSC-certified recycled cardboard and fully recyclable low-density polyethylene, both designed to minimise their use.

Lastly, every day we strive to gradually implement actions to improve our environmental performance by means of LCA (Life Cycle Assessment) analysis, an analytical and systematic methodology that assesses the environmental footprint of our new products throughout their entire life cycle.

For more information visit www.hardioutdoor.com/regeneration

regeneration

Il nostro impegno nel realizzare prodotti dall'alto valore aggiunto e sostenibili per l'ambiente ci ha portati a inaugurare nel 2019 il programma industriale Regeneration per la produzione di arredi per esterno in plastica riciclata.

Li facciamo in uno stabilimento progettato con tecnologie all'avanguardia a livello impiantistico, dotato di presse a iniezione ibride ad alto risparmio energetico nelle quali il sistema di raffreddamento utilizza l'aria senza impiegare acqua e consumando pochissima energia elettrica. Quest'ultima è generata, in gran parte, da un sistema di pannelli fotovoltaici.

Regeneration è molto più di una semplice linea di prodotti in plastica riciclata e ci permette di sperimentare soluzioni applicabili su larga scala a tutto il ciclo produttivo coinvolgendo tutte le fasi, dall'ideazione dei singoli arredi fino al loro imballaggio.

Per quest'ultimo aspetto per la linea Regeneration tutti gli imballi di protezione e i relativi sostegni interni sono in cartone riciclato certificato FSC e polietilene a bassa densità completamente riciclabile, entrambi progettati in modo da ridurre al minimo il loro impiego.

Infine, ci impegniamo ogni giorno a mettere progressivamente in atto azioni per migliorare le nostre performance ambientali grazie alle analisi LCA (Life Cycle Assessment), metodologia analitica e sistematica che valuta l'impronta ambientale dei nostri nuovi prodotti lungo il loro intero ciclo di vita.

Per maggiori informazioni visita www.nardioutdoor.com/regeneration

SIPARIO

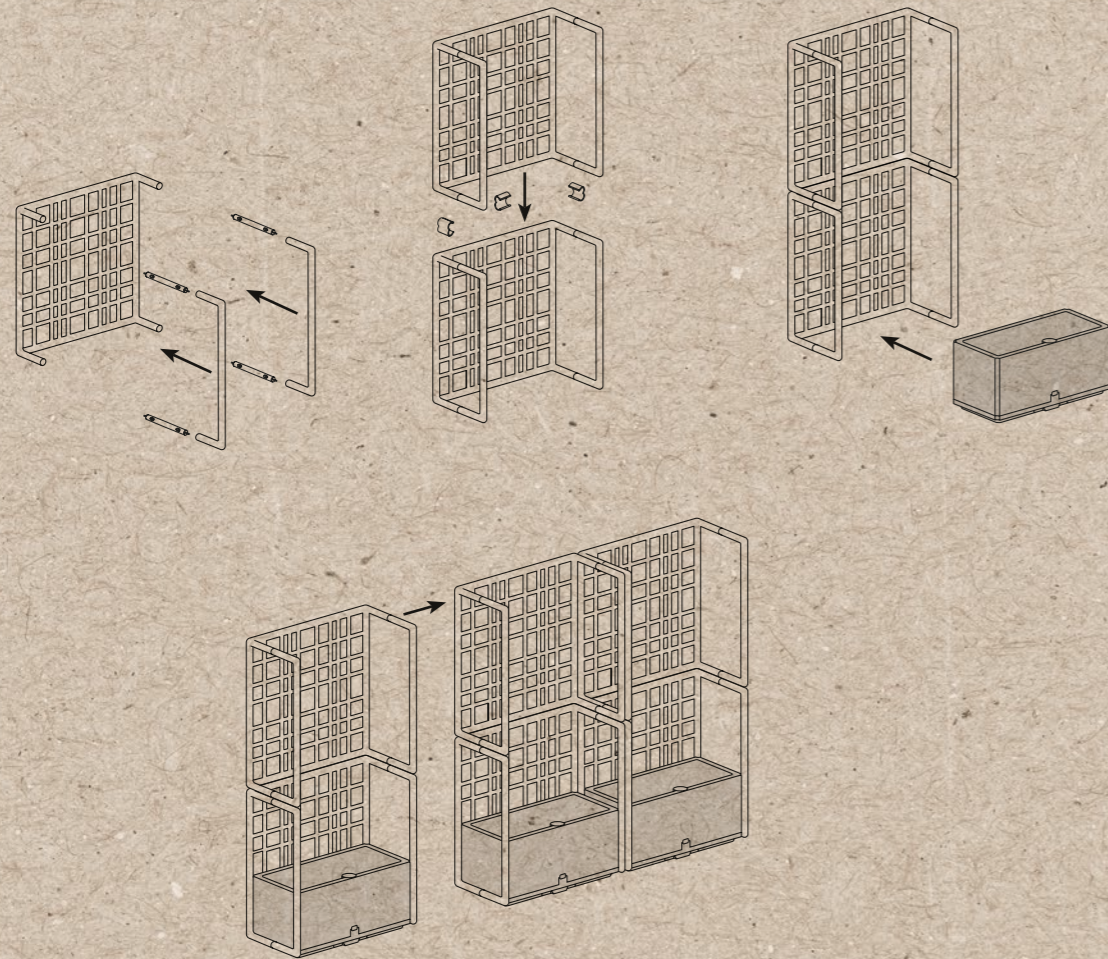

SIPARIO è un divisorio modulare autoportante da esterno configurabile a piacere, ideale per dividere gli spazi aperti. È costituito da elementi grigliati facilmente agganciabili tra loro senza l'uso di viti e dotato di vaso contenitore per piante. È realizzato in plastica rigenerata

SIPARIO, a free-standing modular partition for outdoor use, can be configured as required and is ideal for separating open spaces. It consists of grid elements, easily hooked together without using screws, and includes a container for plants. It's made of regenerated plastic

regeneration

SIPARIO 3

polipropilene fiberglass rigenerato

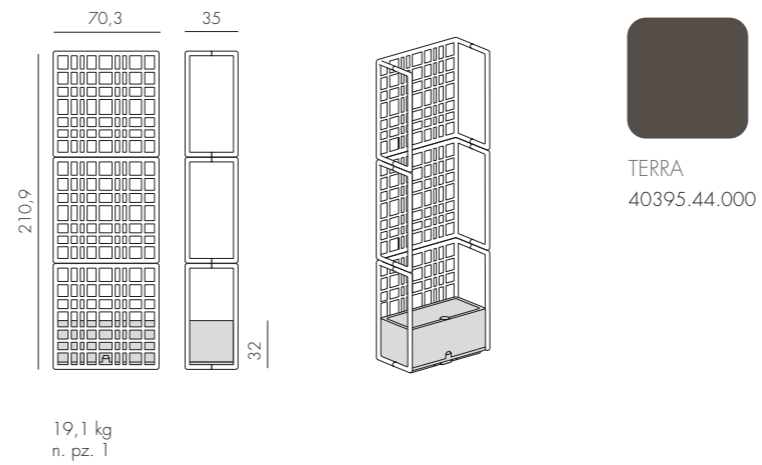

SIPARIO 2



polipropilene fiberglass rigenerato

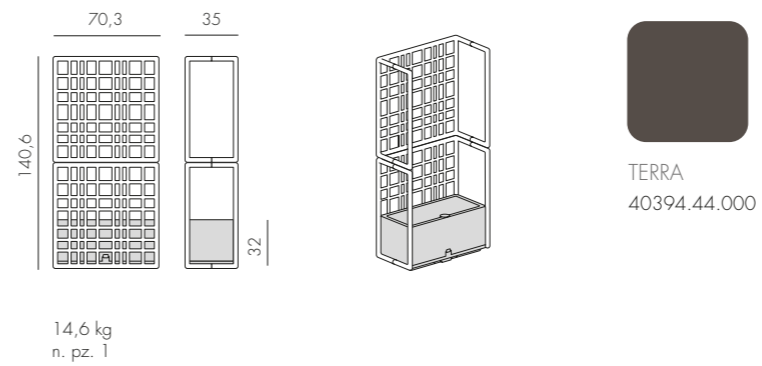

SIPARIO MODULO

polipropilene fiberglass rigenerato

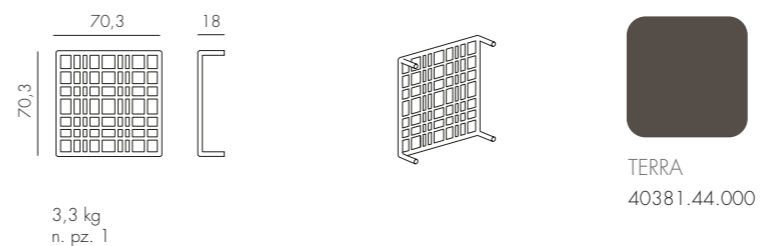

Il polipropilene fiberglass rigenerato può subire delle variazioni di colore dovute all'utilizzo di materiale riciclato - Regenerated fiberglass polypropylene may undergo variations in color due to the use of recycled material - Polypropylène fiberglass régénérée peut subir variations de couleur en raison de l'utilisation de matériaux recyclés - Regeneriertem fiberglass-Polypropylen kann aufgrund der Verwendung von recyceltem Material Farbabweichungen unterliegen - El polipropileno fiberglass regenerado puede sufrir variaciones de color debido al uso de material reciclado - O polipropileno fiberglass regenerado pode sofrer variações de cor devido ao uso de material reciclado - Rejenered edilmis polipropilen fiberglass, geri dönüşüm malzemesi kullanımı nedeniyle renk değişikliklerine maruz kalabilir - Цвет регенированного полипропиленового стекловолокна может претерпевать изменения вследствие использования переработанного материала.



Life Cycle Assessment

For more information visit www.nardioutdoor.com/sustainability

SIPARIO VASO

polipropilene fiberglass rigenerato

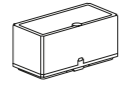
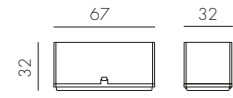

TERRA
40382.44.000

6,4 kg
n. pz. 1

SIPARIO CHIUSURA

polipropilene fiberglass rigenerato

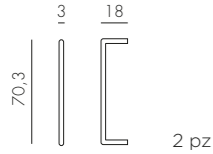

TERRA
40383.44.000

1 kg
n. pz. 1

SIPARIO KIT CLIPS

polipropilene fiberglass rigenerato



TERRA
40392.44.000

0,4 kg
n. pz. 1

accessori
accessories

Il polipropilene fiberglass rigenerato può subire delle variazioni di colore dovute all'utilizzo di materiale riciclato - Regenerated fiberglass polypropylene may undergo variations in color due to the use of recycled material - Polypropylène fiberglass régénérée peut subir variations de couleur en raison de l'utilisation de matériaux recyclés - Regeneriertem fiberglass-Polypropylen kann aufgrund der Verwendung von recyceltem Material Farbabweichungen unterliegen - El polipropileno fiberglass regenerado puede sufrir variaciones de color debido al uso de material reciclado - O polipropileno fiberglass regenerado pode sofrer variações de cor devido ao uso de material reciclado - Rejenere edilmiş polipropilen fiberglass, geri dönüşüm malzemesi kullanımı nedeniyle renk değişikliklerine maruz kalabilir - Цвет регенерированного полипропиленового стекловолокна может претерпевать изменения вследствие использования переработанного материала.

CUSCINO DOGA RELAX **new**

tessuto

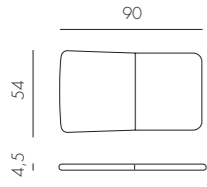

lino
36256.00.152

0,7 kg
n. pz. 4

CUSCINO DOGA ARMCHAIR **new**

tessuto

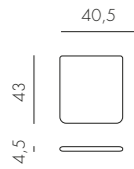

lino
36254.00.152

0,3 kg
n. pz. 4

CUSCINO DOGA BISTROT **new**

tessuto

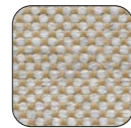
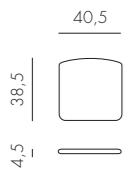

lino
36255.00.152

0,25 kg
n. pz. 4

CUSCINO TRILL

tessuto

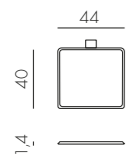

cenere
36253.00.132

Solo per sedia Trill Bistrot - Only for Trill Bistrot chair
- Seulement pour la chaise Trill Bistrot - Nur für Trill
Bistrot Stuhl - Sólo para silla Trill Bistrot - Apenas
para cadeira Trill Bistrot - Sadece Trill Bistrot san-
dalyesi için - Только для кресла Trill Bistrot.

0,2 kg
n. pz. 4

CUSCINO NET BENCH

tessuto

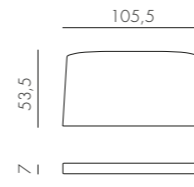

1,5 kg
n. pz. 4



grey stone #
36338.00.064



rosa quarzo #
36338.00.066

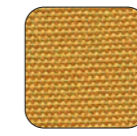

senape #
36338.00.069

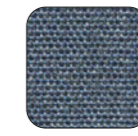

denim #
36338.00.070

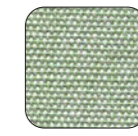

the verde #
36338.00.071

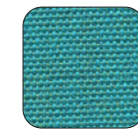

sardinia #
36338.00.072



bianco
36338.00.155



grigio #
36338.00.163



grigio Sunbrella®*
36338.00.136

CUSCINO NET RELAX

tessuto

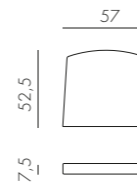

0,8 kg
n. pz. 4



grey stone #
36327.00.064



rosa quarzo #
36327.00.066



senape #
36327.00.069

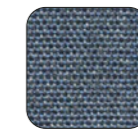

denim #
36327.00.070

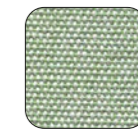

the verde #
36327.00.071

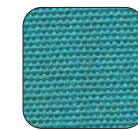

sardinia #
36327.00.072



bianco
36327.00.155



grigio #
36327.00.163



grigio Sunbrella®*
36327.00.136

Variazioni di colore sono da ritenersi standard e naturali nei tessuti acrilici tinto filo. Posizionare in zone d'ombra - Colour variations are to be considered standard and natural in yarn-dyed acrylic fabrics. Position in shaded areas - Les variations de couleur des tissus acryliques au fil teint sont standard et naturelles. Placer dans des zones ombragées - Farbveränderungen sind als Standard und in im Garn gefärbten Acrylgeweben als natürlich zu betrachten. In schattigen Bereichen aufstellen - Las variaciones de color son normales y naturales en las telas acrílicas teñidas en hilo. Colocar en zonas de sombra - As variações de cor são consideradas standard e naturais nos tecidos acrílico tingidos com fio. Posicionar em zonas de sombra - Boyalı akrilik iplik kumaşlarda renk değişiklikleri standart ve doğal kabul edilir. Gölge alanlara yerleştiriniz - Изменения цвета следует считать нормой, они являются естественными в случае акриловых тканей с окрашенными волокнами. Размещать в тени

* Trattamento laminato su richiesta con quantità minima - Laminated finish available on request with a minimum quantity - Traitement laminé sur demande avec une quantité minimum - Lamierte Ausrüstung auf Anfrage mit einer Mindestmenge - Tratamiento laminado bajo pedido con una cantidad mínima - Tratamiento laminado sob encomenda com quantidade mínima - Talep üzerine minimum miktarda lamine işlem - Ламинированная обработка по запросу с минимальным количеством

CUSCINO SHELL (NET RELAX)

tessuto

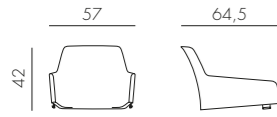

2,2 kg
n. pz. 2

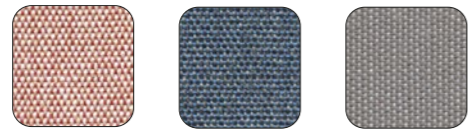

rosa quarzo # 36327.01.066
denim # 36327.01.070
grigio # 36327.01.163

Utilizzabile solo con cuscino Net Relax - Can only be used with Net Relax cushion - À utiliser uniquement avec le coussin Net Relax - Kann nur mit Net Relax Kissen verwendet werden - Se puede utilizar sólo con el cojín Net Relax - Só pode ser usada em conjunto com almofada de assento Net Relax - Sadece Net Relax minderiyile kullanılmalı - Можно использовать только с подушкой Net Relax.

CUSCINO NET

tessuto

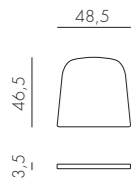

0,3 kg
n. pz. 4

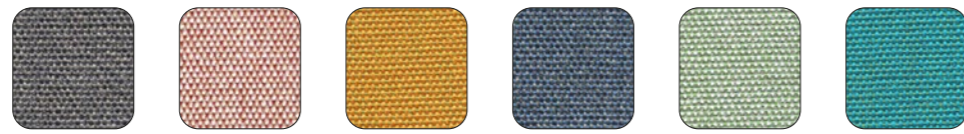

grey stone # 36326.00.064
rosa quarzo # 36326.00.066
senape # 36326.00.069
denim # 36326.00.070
the verde # 36326.00.071
sardinia # 36326.00.072



bianco 36326.00.155
grigio # 36326.00.163
grigio Sunbrella* 36326.00.136

CUSCINO BIT new

tessuto

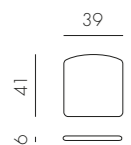

0,3 kg
n. pz. 4



grigio # 36328.00.163

Variazioni di colore sono da ritenersi standard e naturali nei tessuti acrilici tinto filo. Posizionare in zone d'ombra - Colour variations are to be considered standard and natural in yarn-dyed acrylic fabrics. Position in shaded areas - Les variations de couleur des tissus acryliques au fil teint sont standard et naturelles. Placer dans des zones ombragées - Farbveränderungen sind als Standard und in im Garn gefärbten Acrylgeweben als natürlich zu betrachten. In schattigen Bereichen aufstellen - Las variaciones de color son normales y naturales en las telas acrílicas teñidas en hilo. Colocar en zonas de sombra - As variações de cor são consideradas standard e naturais nos tecidos acrílico tingidos com fio. Posicionar em zonas de sombra - Boyalı akrilik iplik kumaşlarda renk değişiklikleri standart ve doğal kabul edilir. Gölge alanlara yerleştiriniz - Изменения цвета следует считать нормой, они являются естественными в случае акриловых тканей с окрашенными волокнами. Размещать в тени

* Trattamento laminato su richiesta con quantità minima - Laminated finish available on request with a minimum quantity - Traitement laminé sur demande avec une quantité minimum - Laminierte Ausrüstung auf Anfrage mit einer Mindestmenge - Tratamiento laminado bajo pedido con una cantidad mínima - Tratamento laminado sob encomenda com quantidade mínima - Talep üzerine minimum miktarda lamine işlem - Ламинированная обработка по запросу с минимальным количеством

CUSCINO PASSEPARTOUT

tessuto

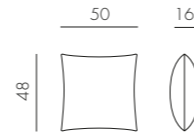

0,7 kg
n. pz. 4

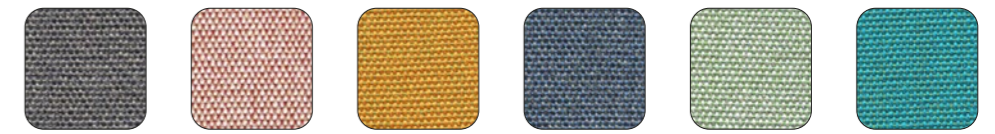

grey stone # 36000.01.064
rosa quarzo # 36000.01.066
senape # 36000.01.069
denim # 36000.01.070
the verde # 36000.01.071
sardinia # 36000.01.072

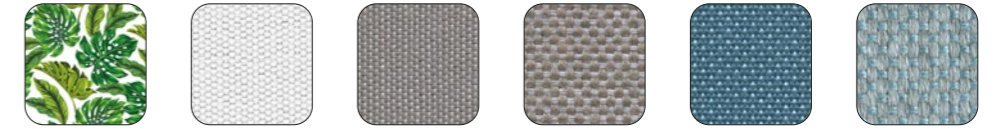

tropical 36000.01.081
bianco 36000.01.155
grigio # 36000.01.163
grigio Sunbrella® 36000.01.136
adriatic Sunbrella® 36000.01.142
ghiaccio Sunbrella® 36000.01.138

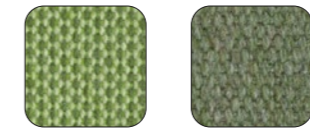

avocado Sunbrella® 36000.01.139
giungla Sunbrella® 36000.01.140

CUSCINO RETTANGOLARE

tessuto

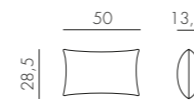

0,55 kg
n. pz. 4

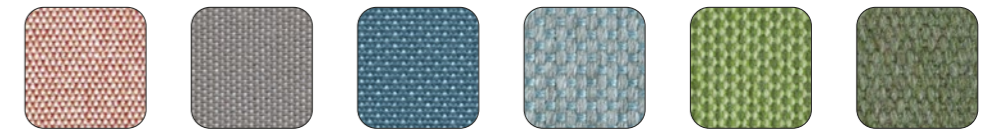

rosa quarzo # 36000.02.066
grigio # 36000.02.163
adriatic Sunbrella® 36000.02.142
ghiaccio Sunbrella® 36000.02.138
avocado Sunbrella® 36000.02.139
giungla Sunbrella® 36000.02.140

Variazioni di colore sono da ritenersi standard e naturali nei tessuti acrilici tinto filo. Posizionare in zone d'ombra - Colour variations are to be considered standard and natural in yarn-dyed acrylic fabrics. Position in shaded areas - Les variations de couleur des tissus acryliques au fil teint sont standard et naturelles. Placer dans des zones ombragées - Farbveränderungen sind als Standard und in im Garn gefärbten Acrylgeweben als natürlich zu betrachten. In schattigen Bereichen aufstellen - Las variaciones de color son normales y naturales en las telas acrílicas teñidas en hilo. Colocar en zonas de sombra - As variações de cor são consideradas standard e naturais nos tecidos acrílico tingidos com fio. Posicionar em zonas de sombra - Boyalı akrilik iplik kumaşlarda renk değişiklikleri standart ve doğal kabul edilir. Gölge alanlara yerleştiriniz - Изменения цвета следует считать нормой, они являются естественными в случае акриловых тканей с окрашенными волокнами. Размещать в тени

COVER SMALL **new** (4/6 SEDUTE / DIVANO 1 ELEMENTO)

tessuto

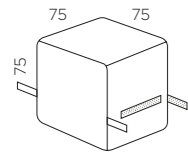

smoke
37000.01.204

COVER MEDIUM **new** (2/4 LETTINI)

tessuto

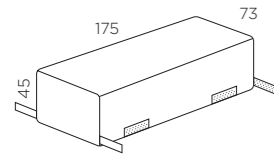

smoke
37000.02.204

COVER LARGE **new** (DIVANO 2 ELEMENTI / TAVOLO 140)

tessuto

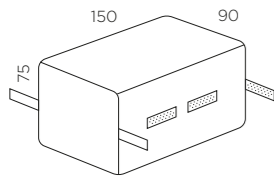

smoke
37000.03.204

COVER EXTRALARGE **new** (DIVANO 3 ELEMENTI / TAVOLO 210)

tessuto

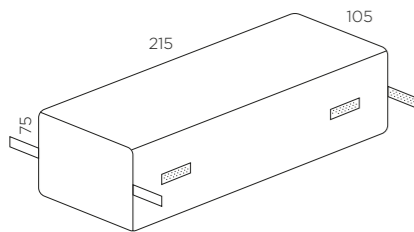

smoke
37000.04.204

materiali
materials

polipropilene

Polipropilene trattato anti-UV e colorato in massa. Riciclabile al 100%.
Polypropylene with UV additives and is uniformly colored. 100% Recyclable resin.
Polypropylène traité anti-UV et coloré dans la masse. Résine recyclable 100%.
UV-beständigem Polypropylen, voll durchgefärbt. 100% Recyclebarer Kunststoff.
Polipropileno tratado anti-UV y teñido en masa. Resina reciclable 100%.
Polipropileno com tratamento anti-UV colorido na totalidade. Resina reciclável 100%.
Işığa dayanıklı ve boyalı olarak granül çekilmiş %100 geri dönüşümlü polipropilen kompozit hammadde.
Полипропилен с обработкой анти-УФ, окрашенное в массе. На 100% пригодно для вторичной переработки.



BIANCO .00



GRIGIO .03



ANTRACITE .02



TORTORA .10



TABACCO .53



CAFFE' .05



OTTANIO .49



SALICE .04



MENTA .15



AGAVE .16



PERA .18



CAPPUCCINO .14



SENAPE .56



ROSA BOUQUET .08



MARSALA .21



CORALLO .75

polipropilene fiberglass

Polipropilene fiberglass trattato anti-UV e colorato in massa. Resina riciclabile al 100%.
Uniformly colored fiberglass polypropylene resins with UV additives. 100% Recyclable resin.
Polypropylène fiberglass traité anti-UV et coloré dans la masse. Résine recyclable 100%.
UV-beständigem fiberglass Polypropylen, voll durchgefärbt. 100% Recyclebarer Kunststoff.
Polipropileno fiberglass tratado anti-UV y teñido en masa. Resina reciclable 100%.
Polipropileno fiberglass com tratamento anti-UV colorido na totalidade. Resina reciclável 100%.
Işığa dayanıklı ve boyalı olarak granül çekilmiş %100 geri dönüşümlü cam elyaf katkılı polipropilen kompozit hammadde.
Полипропилен фиброволокно с обработкой анти-УФ, окрашенное в массе. На 100% пригодно для вторичной переработки.

polipropilene fiberglass rigenerato

Polipropilene fiberglass rigenerato trattato anti-UV e colorato in massa. Resina riciclabile al 100%. Il polipropilene fiberglass rigenerato può subire delle variazioni di colore dovute all'utilizzo di materiale riciclato.
Regenerated uniformly colored fiberglass polypropylene resins with UV additives. 100% Recyclable resin. Regenerated fiberglass polypropylene may undergo variations in color due to the use of recycled material.
Polypropylène fiberglass régénérée traité anti-UV et coloré dans la masse. Résine recyclable 100%. Polypropylène fiberglass régénérée peut subir variations de couleur en raison de l'utilisation de matériaux recyclés.
Regeneriertem UV-beständigem fiberglass-Polypropylen, voll durchgefärbt. 100% Recyclebarer Kunststoff. Regeneriertem fiberglass-Polypropylen kann aufgrund der Verwendung von recyceltem Material Farbabweichungen unterliegen.

Polipropileno fiberglass regenerado tratado anti-UV y teñido en masa. Resina reciclable 100%. El polipropileno fiberglass regenerado puede sufrir variaciones de color debido al uso de material reciclado.
Polipropileno fiberglass regenerado com tratamento anti-UV colorido na totalidade. Resina reciclável 100%. O polipropileno fiberglass regenerado pode sofrer variações de cor devido ao uso de material reciclado.
UV katlı maddeleriyle fiberglass polipropilen reçine ile renklendirilip düzgün bir şekilde tekrar oluşturulmuştur. Rejenere edilmiş polipropilen fiberglass, geri dönüşüm malzemesi kullanımı nedeniyle renk değişikliklerine maruz kalabilir.
Переработанный, крашеный, полипропилен fiberglass обработанный против проникновения ультрафиолетовых лучей. На 100% пригодно для вторичной переработки. Цвет регенерированного полипропиленового стекловолокна может претерпеть изменения вследствие использования переработанного материала.



TERRA .44

tessuto acrilico



Fibra acrilica 100% tinto filo. Trattamento antimacchia, antimuffa. Solidità alla luce 5/8. Lavabile a 30°.
 100% yarn dyed acrylic. Dirt repellent and anti-mould treatment. 5/8 light fastness. Washable at 30°.
 100% fibre acrylique teintée en fils. Traitement anti-taches et anti-moisissure. Résistance à la lumière 5/8. Lavable à 30°.
 100% garngefärbtes Polyacryl Gewebe. Gegen Flecken und Schimmel Ausrüstung. Lichtechtheit 5/8. Waschbar bei 30°.

100% hilo teñido acrílico. Protección antimanchas, antimoho. Solidez a la luz 5/8. Lavable a 30°.
 100% fibra acrílica tingida com fio. Tratamento antimancha e antimoho. Resistência à luz 5/8. Lavável a 30°.
 %100 akrilik elyaf boyalı iplik. Leke itici, küf önleyici ile muamele edilmiş. Işık haslığı 5/8. 30°de yıkanabilir.
 Акриловое волокно 100% окрашенное в пряде. Пятноустойчивая и противоплесневая обработка. Светостойкость 5/8. Стирать при 30°.

Variazioni di colore sono da ritenersi standard e naturali nei tessuti acrilici tinto filo. Posizionare in zone d'ombra - Colour variations are to be considered standard and natural in yarn-dyed acrylic fabrics. Position in shaded areas - Les variations de couleur des tissus acryliques au fil teint sont standard et naturelles. Placer dans des zones ombragées - Farbveränderungen sind als Standard und in im Garn gefärbten Acrylgeweben als natürlich zu betrachten. In schattigen Bereichen aufstellen - Las variaciones de color

son normales y naturales en las telas acrílicas teñidas en hilo. Colocar en zonas de sombra - As variações de cor são consideradas standard e naturais nos tecidos acrílico tingidos com fio. Posicionar em zonas de sombra - Boyalı akrilik iplik kumaşlarda renk değişiklikleri standart ve doğal kabul edilir. Gölge alanlara yerleştiriniz - Изменения цвета следует считать нормой, они являются естественными в случае акриловых тканей с окрашенными волокнами. Размещать в тени.

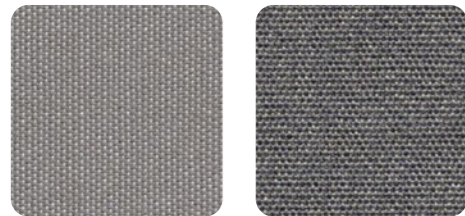

grigio .163
240 gr/m²

grey stone .064
240 gr/m²

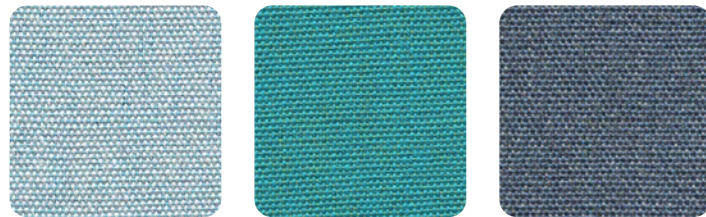

artic .161
240 gr/m²

sardinia .072
240 gr/m²

denim .070
240 gr/m²

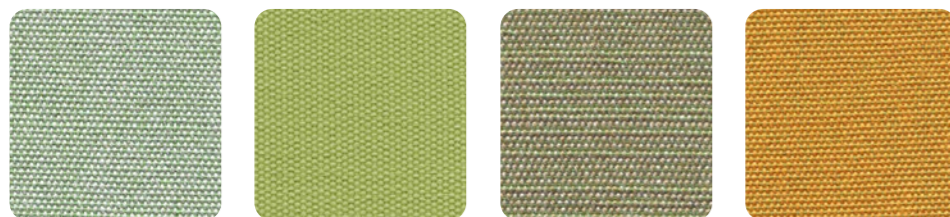

the verde .071
240 gr/m²

lime .061
240 gr/m²

felce .162
240 gr/m²

senape .069
240 gr/m²

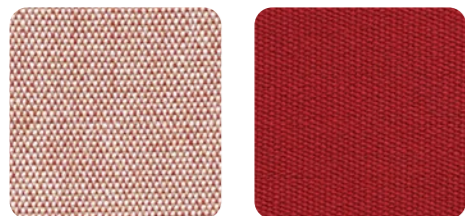

rosa quarzo .066
240 gr/m²

cherry .065
240 gr/m²

tessuto acrilico Sunbrella®



100% fibra acrilica Sunbrella® tinto in massa. Trattamento idrorepellente, antimacchia, antimuffa. Solidità alla luce 8/8. Lavabile a 40°.
 100% Sunbrella® acrylic fiber mass dyed. Water repellent treatment, dirt repellent and anti-mould treatment. 8/8 light fastness. Washable at 40°.
 100% fibre acrylique Sunbrella® teintée en masse. Traitement imperméable, anti-taches et anti-moisissure. Résistance à la lumière 8/8. Lavable à 40°.
 100% fasergefärbtes Sunbrella® Polyacryl. Wasserabweisend Ausrüstung, gegen Flecken und Schimmel ausgerüstet. Lichtechtheit 8/8. Waschbar bei 40°.

100% fibra acrílica Sunbrella® tintada en masa. Tratamiento por la repelencia al agua, protección antimanchas, antimoho. Solidez a la luz 8/8. Lavable a 40°.
 100% fibra acrílica Sunbrella® tingida em massa. Tratamento hidrorrepelente, antimancha e antimoho. Resistência à luz 8/8. Lavável a 40°.
 %100 akrilik elyaf Sunbrella® çözelti halindeyken boyanmış. Su itici, leke itici, küf önleyici ile muamele edilmiş. Işık haslığı 8/8. 40°de yıkanabilir.
 100% акриловое волокно Sunbrella®, окрашенное в массе. Водоотталкивающая, пятноустойчивая и противоплесневая обработка. Светостойкость 8/8. Стирать при 40°.

★ 50% fibra acrilica Sunbrella® riciclata tinto in massa, 47% fibra acrilica Sunbrella® tinto in massa, 3% poliester.
 50% blended Sunbrella® acrylic fiber mass dyed, 47% Sunbrella® acrylic fiber mass dyed, 3% polyester.
 50% fibre acrylique Sunbrella® recyclée teintée en masse, 47% fibre acrylique Sunbrella® teintée en masse, 3% de polyester.
 50% fasergefärbtes, recycletes Sunbrella® Polyacryl, 47% fasergefärbtes Sunbrella® Polyacryl, 3% Polyester.

50% fibra acrílica Sunbrella® reciclada tintada en masa, 47% fibra acrílica Sunbrella® tintada en masa, 3% poliéster.
 50% fibra acrílica Sunbrella® reciclada tingida em massa, 47% fibra acrílica Sunbrella® tingida em massa, 3% de poliéster.
 %50 geri dönüştürülmüş akrilik elyaf Sunbrella® çözelti halindeyken boyanmış, %47 akrilik elyaf Sunbrella® çözelti halindeyken boyanmış, % 3 polyester.
 50% переработанное акриловое волокно Sunbrella® окрашенное в массе, 47% акриловое волокно Sunbrella®, окрашенное в массе, 3% полиэстер.

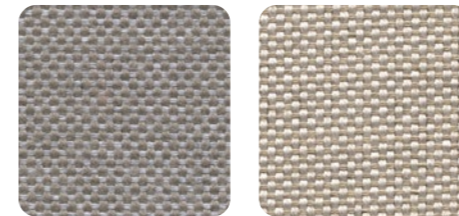

grigio Sunbrella® .136
275 gr/m²

canvas Sunbrella® .141
275 gr/m²

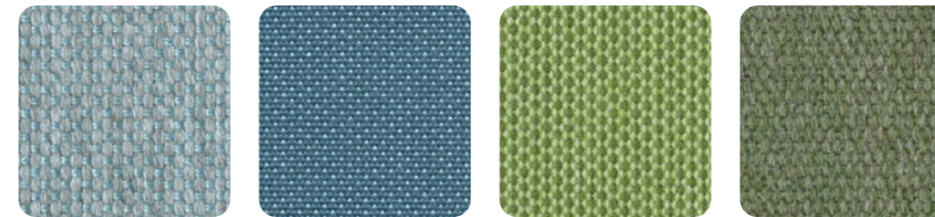

ghiaccio Sunbrella® .138
275 gr/m²

adriatic Sunbrella® .142
260 gr/m²

avocado Sunbrella® .139
260 gr/m²

giungla Sunbrella® .140 ★
340 gr/m²

Sunbrella® EXTRA



Tessuti disponibili su ordinazione per minimi quantitativi d'ordine solo per il prodotto KOMODO.
Fabrics available to order for minimum order quantities for the KOMODO product only.
Tissus disponibles sur commande de quantités minimales pour le produit KOMODO uniquement.
Gewebe auf Bestellung für Mindestbestellmengen nur für das Produkt KOMODO erhältlich.

Telas disponibles bajo pedido para cantidades mínimas solo para el producto KOMODO.
Tecidos disponíveis por encomenda para quantidades mínimas de encomenda apenas para o produto KOMODO.
Sadece KOMODO ürünü için minimum sipariş miktarına göre sipariş verilebilecek kumaşlar.
ткани на заказ для минимального объема заказа только для изделия KOMODO.



marble
Sunbrella® .186
260 gr/m²

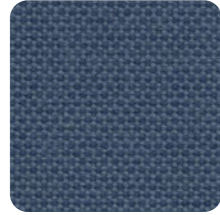

blue storm
Sunbrella® .185
260 gr/m²

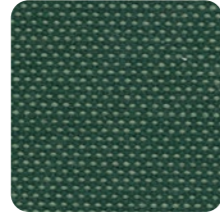

alpine
Sunbrella® .182
260 gr/m²



mink brown
Sunbrella® .183
260 gr/m²

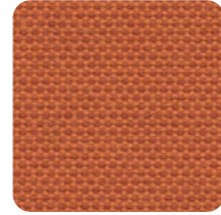

pumpkin
Sunbrella® .184
260 gr/m²

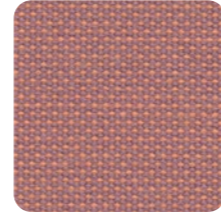

opera
Sunbrella® .187
260 gr/m²

trattamento laminato

(Su richiesta - On request - Sur demande - Auf Anfrage - Bajo pedido - Sob encomenda - İstek üzerine - По запросу)



Il tessuto è accoppiato internamente con un film in poliuretano che lo rende impermeabile. La parte accoppiata in poliuretano non deve essere esposta al sole. Applicabile su richiesta con quantità minima su tessuti acrilici Sunbrella®.
The fabric is bonded with a polyurethane film that makes it waterproof. The polyurethane laminated surface should not be exposed to direct sunlight. Applicable on Sunbrella® acrylic fabrics on request with a minimum quantity.
Le tissu est doublé en interne avec un film de polyuréthane qui le rend imperméable. La partie en polyuréthane ne doit pas être exposée au soleil. Applicable sur demande avec une quantité minimale sur les tissus acryliques Sunbrella®.
Das Gewebe ist innen mit einer Polyurethanfolie verbunden, die es wasserdicht macht. Das mit Polyurethan verbundene Teil darf nicht der Sonne ausgesetzt werden. Auf Anfrage mit Mindestmenge auf Sunbrella® Polyacryl Gewebe anwendbar.

El tejido está acoplado internamente con una película de poliuretano que lo hace impermeable. La parte acoplada de poliuretano no debe exponerse al sol. Aplicable bajo pedido con una cantidad mínima en tejidos acrílicos Sunbrella®.
O tecido é dublado com filme interno de poliuretano que o torna impermeável. O lado que possui o filme de poliuretano não pode ser exposta ao sol. Aplicável sob encomenda, com quantidade mínima, em tecidos acrílicos Sunbrella®.
Kumaş, su geçirmez hale getiren bir poliüretan film ile dahili olarak birleştirilmiştir. Birleştirilmiş poliüretan bölümler güneşe maruz bırakılmamalıdır. Sunbrella® akrilik kumaşlar üzerine minimum miktarda istek üzerine uygulanabilir.
Ткань внутренне соединена с полиуретановой пленкой, которая делает ее водонепроницаемой. та часть ,где имеется добавка полиуритана не выставлять на солнце. Применяется по запросу с минимальным количеством на акриловых тканях Sunbrella®.

tessuto acrilico tinto massa



100% fibra acrilica tinto in massa. Trattamento idrorepellente, antimacchia, antimuffa. Solidità alla luce 7/8. Lavabile a 30°.
100% acrylic fiber mass dyed. Water repellent treatment, dirt repellent and anti-mould treatment. 7/8 light fastness. Washable at 30°.
100% fibre acrylique teintée en masse. Traitement imperméable, anti-taches et anti-moisissure. Résistance à la lumière 7/8. Lavable à 30°.
100% fasergefärbtes Polyacryl. Wasserabweisend Ausrüstung, gegen Flecken und Schimmel ausgerüstet. Lichtechtheit 7/8. Waschbar bei 30°.

100% fibra acrilica tintada en masa. Tratamiento hidropelente, protección antimanchas, antimoho. Solidez a la luz 7/8. Lavable a 30°.
100% fibra acrilica tingida em massa. Tratamento hidropelente, antimancha e antimofa. Resistência à luz 7/8. Lavável a 30°.
%100 akrilik elyaf çözümlü halindeyken boyanmış. Su itici, leke itici, küf önleyici ile muamele edilmiş. Işık haslığı 7/8. 30°de yıkanabilir.
100% акриловое волокно окрашенное в массе. Водоотталкивающая, пятноустойчивая и противоплесневая обработка. Светостойкость 7/8. Стирать при 30°.



lino .152
280 gr/m²



grigio Komodo .172
240 gr/m²

tessuto acrilico tinto massa per Komodo ombra



100% fibra acrilica tinto in massa. Trattamento idrorepellente, antimacchia, antimuffa. Solidità alla luce 7-8/8. Lavabile a 30°. Il tessuto Velo deve essere impiegato solo come telo-parasole. La maglia larga permette l'aerazione e allo stesso tempo crea una zona d'ombra sottostante ma non trattiene l'acqua.
100% acrylic fiber mass dyed. Water repellent treatment, dirt repellent and anti-mould treatment. 7-8/8 light fastness. Washable at 30°. Velo fabric should only be used for sunshades. Its wide mesh allows ventilation while creating a shaded area below, but it does not retain water.
100% fibre acrylique teintée en masse. Traitement imperméable, anti-taches et anti-moisissure. Résistance à la lumière 7-8/8. Lavable à 30°. Le tissu Velo ne doit être utilisé que comme toile de parasol. Les mailles larges permettant de s'aérer tout en créant, en même temps, une zone d'ombre en dessous. Velo n'est pas imperméable.
100% fasergefärbtes Polyacryl. Wasserabweisend Ausrüstung, gegen Flecken und Schimmel ausgerüstet. Lichtechtheit 7-8/8. Waschbar bei 30°. Das Gewebe Velo darf nur als Sonnenschutz Tuch verwendet werden. Die großen Maschen gestatten die Belüftung und gleichzeitig bildet sich darunter ein Schattenbereich, doch es hält Wasser nicht zurück.
100% fibra acrilica tintada en masa. Tratamiento hidropelente, protección antimanchas, anti-

moho. Solidez a la luz 7-8/8. Lavable a 30°. La tela Velo debe utilizarse únicamente como parasol, la malla ancha permite la ventilación y crea por debajo una zona de sombra, pero no protege del agua.
100% fibra acrilica tingida em massa. Tratamento hidropelente, antimancha e antimofa. Resistência à luz 7-8/8. Lavável a 30°. O tecido Velo deve ser utilizado apenas como pano guarda-sol, a malha larga permite o arejamento e ao mesmo tempo cria uma zona de sombra subjacente, mas não retém a água.
%100 akrilik elyaf çözümlü halindeyken boyanmış. Su itici, leke itici, küf önleyici ile muamele edilmiş. Işık haslığı 7-8/8. 30°de yıkanabilir. Velo dokuma sadece güneşlik olarak kullanılmalıdır, geniş gözenekler havalandırma sağlar ve aynı zamanda aşağıda bir gölge alanı oluşturur, fakat su tutma özelliği yoktur.
100% акриловое волокно, окрашенное в массе. Водоотталкивающая, пятноустойчивая и противоплесневая обработка. Светостойкость 7-8/8. стирать при 30°. Ткань Velo предназначена исключительно для использования в качестве тента для защиты от солнца. Переплетение в виде крупной сетки обеспечивает вентиляцию и в то же время создает затенение под собой, но не задерживает влагу.



velo white .203
150 gr/m²

tessuto acrilico stampato



Fibra acrilica 100% stampa digitale. Solidità alla luce 6. Lavabile a 30°.
100% acrylic fiber with digital print. 6 light fastness. Washable at 30°.
100% fibre acrylique impression numérique. Résistance à la lumière 6. Lavable à 30°.
100% Polyacrylfaser mit Digitaldruck. Lichtechtheit 6. Waschbar bei 30°.
100% fibra acrilica impresión digital. Solidez a la luz 6. Lavable a 30°.

100% fibra acrilica estampa digital. Resistência à luz 6. Lavável a 30°.
%100 dijital baskı akrilik elyaf. Işık haslığı 6. 30°de yıkanabilir.
100% акриловое волокно с цифровым рисунком, окрашенное в процессе производства. Светостойкость 6. Стирка при 30°.



tropical .081
190 gr/m²

tessuto sintetico

Tessuto in filo di poliestere rivestito in pvc.
Fabric is made of a polyester fiber, with a pvc coating.
Tissu en fil de polyester revêtu de pvc.
Gewebe aus PVC-ummantelten Polyesterfasern.

Tejido en hilo de poliéster recubierto de pvc.
Tecido de fibra polyester com cobertura pvc.
PVC kaplı polyester elyaf tekstil.
Ткань из полиэфирных нитей с покрытием из ПВХ.

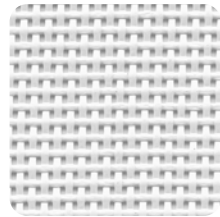

bianco .107
tela 1x1

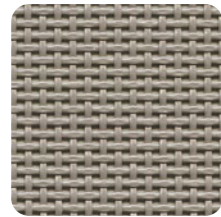

tortora .104
tela 1x1

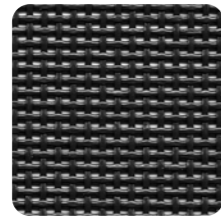

antracite .057
tela 1x1

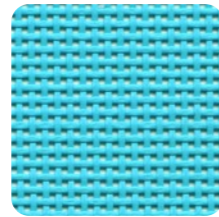

celeste .075
tela 1x1

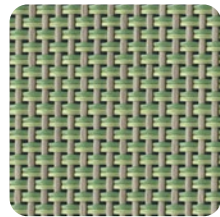

agave .101
tela 2x1

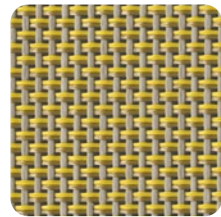

deserto .103
tela 2x1

tessuto Cover

56% poliestere e 44% poliuretano. Trattamento idrorepellente, antimacchia, antimuffa e antibatterico. Solidità alla luce 7/8. Lavabile a 95° con detergente neutro.
56% polyester and 44% polyurethane. The treatment makes the coating: water repellent, and resistant to staining, resistant to mold and antibacterial. 7/8 light fastness. Washable at 95° with neutral detergent.
56% polyester et 44% polyuréthane. Traitement imperméable, anti-taches, anti-moisissures et antibactérien. Résistance à la lumière 7/8. Lavable à 95° avec un détergent neutre.
56% Polyester und 44% Polyurethan. Wasserabweisend, gegen Flecken und Schimmelbildung ausgerüstet und antibakteriell. Lichtechtheit 7/8. Waschbar bei 95° mit Neutralwaschmittel.

56% poliéster y 44% poliuretano. Tratamiento para repeler el agua, antimanchas, antimoho y antibacteriano. Solidez a la luz 7/8. Lavable a 95° con detergente neutro.
56% de poliéster e 44% poliuretano. Tratamento hidrorrepelente, antimancha, antimoho e antibacteriano. Resistência à luz 7/8. Lavável a 95° com detergente neutro.
% 56 polyester ve % 44 poliüretan. Su Geçirmez Uygulama, kir tutmaz ve küf önleyici uygulama, antibakteriyel uygulama. Işık haslığı 7/8. Naturel deterjanla 95°de yıkanabilir.
56% полиэстер и 44% полиуретан. типы обработки: водоталкивающая,пятноталкиваю щая,плесеньоталкивающая, и антибактериальная устойчиво к. Светостойкость 7/8. Можно стирать при 95 ° с нейтральным мощным средством.



smoke .204
205 gr/m²

alluminio verniciato

La verniciatura è a polvere di poliestere.
The painting is with polyester powder.
La peinture est à poudre de polyester.
Die Epoxierung erfolgt mit Polyesterpulver.

El pintado se realiza con polvo de poliéster.
O pó de poliéster é usado para envernizar.
Boyası polyester tozla yapılır.
Окраска производится при помощи порошкового полиэстера.



verniciato bianco .53



verniciato tortora .59



verniciato caffè .57



verniciato antracite .52

laminato HPL (10 mm)

Laminato decorativo ad alta pressione, compatto, omogeneo, non poroso, ad alta densità. Spessore 10 mm.
Decorative high pressure laminate, solid, homogeneous, non-porous and with a high density. Thickness 10 mm.
Stratifié décoratif à haute pression, condensé, homogène, pas poreux, haute densité. Epaisseur 10 mm.
HPL-Laminat, beständig, homogen, hoch verdichtet. Dicke 10 mm.

Laminado decorado a alta presión, compacto, homogéneo, no poroso y de alta densidad. Espesor 10 mm.
Decorativo e laminado a alta pressão, sólido, homogéneo, não poroso e de grande densidade. Espessura 10 mm.
Dekoratif yüksek basınçlı laminat, masif, gözeneksiz ve yüksek yoğunluklu. Kalınlık 10 mm.
Декоративный ламинат высокого давления, компактный, однородный, непористый, с высокой плотностью. Толщина 10 мм.



BIANCO .301



ANTRACITE .303

vetro

Vetro float temperato serigrafato e vetrificato a 700°C. Spessore 10 mm.
Tempered float glass, screen-printed and vitrified at 700° C. Thickness 10 mm.
Verre float trempé sérigraphié et vitrifié à 700°C. Epaisseur 10 mm.
Sicherheitsglas mit innenliegendem Dekorsiebdruck, verglast bei 700°. Dicke 10 mm.
Vidrio float, templado, serigrafado y vetrificado a 700°C. Espesor 10 mm.
Vidro float temperado, impresso e vitrificado a 700°C. Espessura 10 mm.
Temperli, üstü baskılı ve 700° C vitrifiye edilmiş. Kalınlık 10 mm.
Сериграфированное закаленное стекло float, производимое при 700°C. Толщина 10 мм.



BIANCO .00



ANTRACITE .02

vetro

Vetro extrachiaro temperato. Spessore 6 mm.
Extra-clear tempered glass. Thickness 6 mm.
Verre trempé extra clair. Epaisseur 6 mm.
Extra klares gehärtetes Glas. Dicke 6 mm.
Vidrio templado extra claro. Espesor 6 mm.
Vidro temperado extra claro. Espessura 6 mm.
Ekstra net temperli cam. Kalınlık 6 mm.
Особо прозрачное закаленное стекло. Толщина 6 мм.

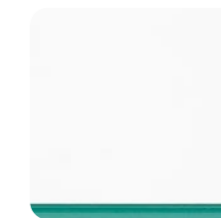

vetro .501

durelTOP





DurelTOP è un sistema innovativo di produzione di piani per tavoli studiati per raggiungere i più elevati livelli di praticità, resistenza, robustezza ed eleganza. I piani DurelTOP sono ad alto spessore, formati da un doppio strato tamburato perfettamente chiuso. Prodotti in polipropilene di prima qualità, sono inalterabili all’acqua, resistenti al sole e facili da pulire. DurelTOP è il risultato di una lunga ricerca tecnologica e dell’esperienza decennale nella lavorazione delle materie plastiche della NARDI, da sempre all’avanguardia nell’ambiente contract e giardino.

The DurelTOP is an innovative new system in the production of tabletops developed to reach the highest levels of practicality, resistance, and elegance. The DurelTOP tabletops have a greater thickness, formed by a double layer enclosure perfectly closed. Produced in first quality polypropylene, they are resistant to water, resistant to sunlight, and are easy to clean. DurelTOP is a result of a decade’s long research and development in plastics by NARDI, always a leader in the contract and garden sectors.

DurelTOP est un système innovateur de production de plateaux de tables, il est étudié pour retrouver le meilleur niveau de pratique de résistance et d’élégance. Les plateaux DurelTOP sont très épais, formés de doubles couches parfaitement finies. Ce sont des produits en polypropylène de première qualité, ils sont inaltérables à l’eau, résistant au soleil et faciles à nettoyer. DurelTOP est le résultat d’une longue recherche technologique et une expérience décennale dans le travail des matières plastique de la Sté NARDI, toujours a l’avantgarde dans le secteur du contract et jardin.

DurelTOP ist ein neu entwickeltes System für die Produktion von Tischplatten, um ein Höchstmaß an Funktionalität, Widerstandsfähigkeit und Eleganz zu erreichen. Durch das innen verstärkte “Zwei-Schichten-Hohlraum-System” erreicht die DurelTOP Tischplatte einen stärkeren Querschnitt und damit ein Höchstmaß an Festigkeit. Hergestellt aus hochwertigem Qualitätspolypropylen ist sie resistent gegen Wasser und Sonnenlicht und dabei leicht zu reinigen. DurelTOP ist das Ergebnis von 10 Jahren Forschung und Entwicklung auf dem Kunststoffsektor durch NARDI, immer der führende im Bereich Contract und Gartenmöbel.



	impilabile stackable empilable stapelbar apilable empilhável istiflenebilir стекируемые
	reclinabile reclining dossier réglable verstellbare Rückenlehne reclinable reclinável sırt pozisyonlu откидной

Tutte le sedute sono dotate di piedini antiscivolo. All chairs are equipped with non-slip feet. Tous les sièges sont équipés avec patins anti-dérapants. Alle Stühle sind mit rutschfesten Fußkappen ausgestattet. Todos los asientos están equipados con tapones antideslizantes. Todos os assentos estão equipados com pés antiderrapantes. Bütün sandalyeler kaymaz ayaklıdırlar. Ножки всех стульев оснащены противоскользящей резиновой подложкой.



Sui colori scuri, ombre, striature ed altri difetti minori sono più evidenti rispetto ai colori chiari e sono da ritenersi standard. On dark colors, shadows, streaks and other minor faults are more evident than on lighter colors and are therfore standard. Sur les couleurs sombres, les ombres, les stries et les autres petits défauts sont plus marqués que sur les couleurs claires et sont tout à fait standards. Auf dunklen Farben sind Schatten, Streifen und andere kleinere Mängel sichtbarer als auf hellen Farben und sind daher als Standard zu betrachten. Las sombras, rayas y demás defectos menores son más evidentes sobre los colores oscuros respecto a los colores claros y tienen que considerarse como estándares. Em cores escuras, sombras, listras e outros defeitos menores são mais evidentes do que em cores claras e devem ser considerados standard. Koyu renkler üzerinde, gölgeler, çizgiler ve diğer küçük defolar açık renkler üzerinde olduklarından daha belirginleşmekte ve bu nedenle normal olarak değerlendirilmelidirler. По сравнению со светлыми цветами на темных цветах тени полоска и другие небольшие дефекты более заметны и должны считаться нормой.

DurelTOP table with a double layer enclosure perfectly closed.

Il peso (kg), le misure (cm) e i colori riportati sono indicativi. La NARDI si riserva il diritto di apportare modifiche o varianti senza preavviso. Tutti i modelli sono depositati. Weights (kg), dimensions (cm) and colors are indicative only. NARDI reserves the right to make changes or variations without notice. All models are patented. Le poids (kg), les dimensions (cm) et les coloris indiqués sont fournis purement à titre indicatif. La Firme NARDI se réserve le droit d’apporter toute modification ou variation sans aucun préavis. Tous les modèles sont déposés. Alle Farb-, Maß- (cm) und Gewichtsangaben (kg) sind nicht als fest binded anzusehen Firma NARDI behält sich das Recht von Änderungen Alle Modelle sind gesetzlich geschützt. El peso (kg), las medidas (cm) y los colores detallados, son indicativos. La firma NARDI se reserva el derecho de modificaciones o variaciones sin previo aviso. Todos los modelos llevan nuestra marca. O peso (kg), as medidas (cm) e as cores indicadas, são indicativos. A NARDI reservase o direito de aportar modificações ou variações sem préaviso. Todos os modelos estão depositados. Ağırlık (Kg), boyutlar (cm) ve renkler gösterme amaçlıdır. NARDI'nin önceden bildirmeden değişiklik yapma hakkı vardır. Bütün modeller patentlidir. Приведенный вес (кг), размеры (см) и цвета являются ориентировочными. Компания NARDI оставляет за собой права вносить изменения и вариации без предварительного предупреждения. Все модели зарегистрированы.

DurelTOP es un nuevo sistema de fabricación de tableros de mesa estudiado para alcanzar los mas alstos niveles de practicidad, resistencia, robustez y elegancia. Los tableros DurelTOP de gran solidez, estan formados por una doble capa perfectamente unida y sellada. Fabricados en polipropileno de primera calidad son inalterables al agua, resistentes al sol y de fácil limpieza. DurelTOP es el resultado de una prolongada investigación tecnológica y de la experiencia acumulada en los mas de diez años que NARDI lleva produciendo materias plasticas, siempre innovando en ambientes contract y jardin.

DurelTOP é um sistema de inovação da produção de tampos de mesa concebidos para atingir a máxima resistência,práticos e elegantes. Os tampos de mesa DurelTOP são formados poruma camada dupla e perfeitamente unida. Produzidos em polipropileno de primeira qualidade, são resistentes ao sol e fáceis de limpar. DurelTOP é o resultado de uma longa investigação tecnológica em materiais plásticos da NARDI, leader em mobiliário de jardim.

DurelTOP, masa tablalarının üretiminde kullanılan yeni bir sistem olup, yüksek seviyede pratiklik, direnç ve de şıklık sunmak amacıyla geliştirilmiştir. DurelTOP masa tablaları fevkalade bir inceliğe sahip olup, kusursuz kapanan çift tabaka çevirme sistemiyle oluşturulmuştur. Nitelikli çamsakızından üretilmiş olup, suya ve güneş ışığına karşı dirençli ve temizlenmesi kolaydır. DurelTOP sistemini Contract ve de Bahçe sektöründe her zaman lider olan NARDI'nin uzun araştırmalarının sonucundan doğan, plastikte gelişim olarak adlandırabiliriz.

DurelTOP — это инновационная система производства столешниц, позволяющая изготавливать практичные, прочные, крепкие и элегантные столешницы. Столешницы DurelTOP обладают высокой плотностью и состоят из двойной панели с мелкопустотным заполнением, полностью закрытой. Изделия из полипропилен высокого качества устойчивы к воде, солнцу и просты в уходе. DurelTOP — это результат многолетних технологических исследований и десятилетнего опыта NARDI в обработке пластмасс, лидера в производстве садовой мебели и контрактном секторе.

NARDI s.p.a.
Chiampo (VI) Italy
tel. +39 0444 422100
info@nardioutdoor.com
www.nardioutdoor.com



10101127